

The Alumil logo is displayed in a bold, dark blue font within a bright yellow diamond-shaped graphic. The background of the entire image is a dark grey-blue with diagonal stripes of yellow and dark grey. On the right side, a close-up of a silver Alumil door handle is visible, set against a blurred outdoor scene of a poolside patio.

Alumil

The Alumil logo is shown in white on a dark grey-blue background, followed by the word 'HANDLES' in a white, sans-serif font. A yellow diamond shape is positioned between the logo and the text.

Alumil  **HANDLES**

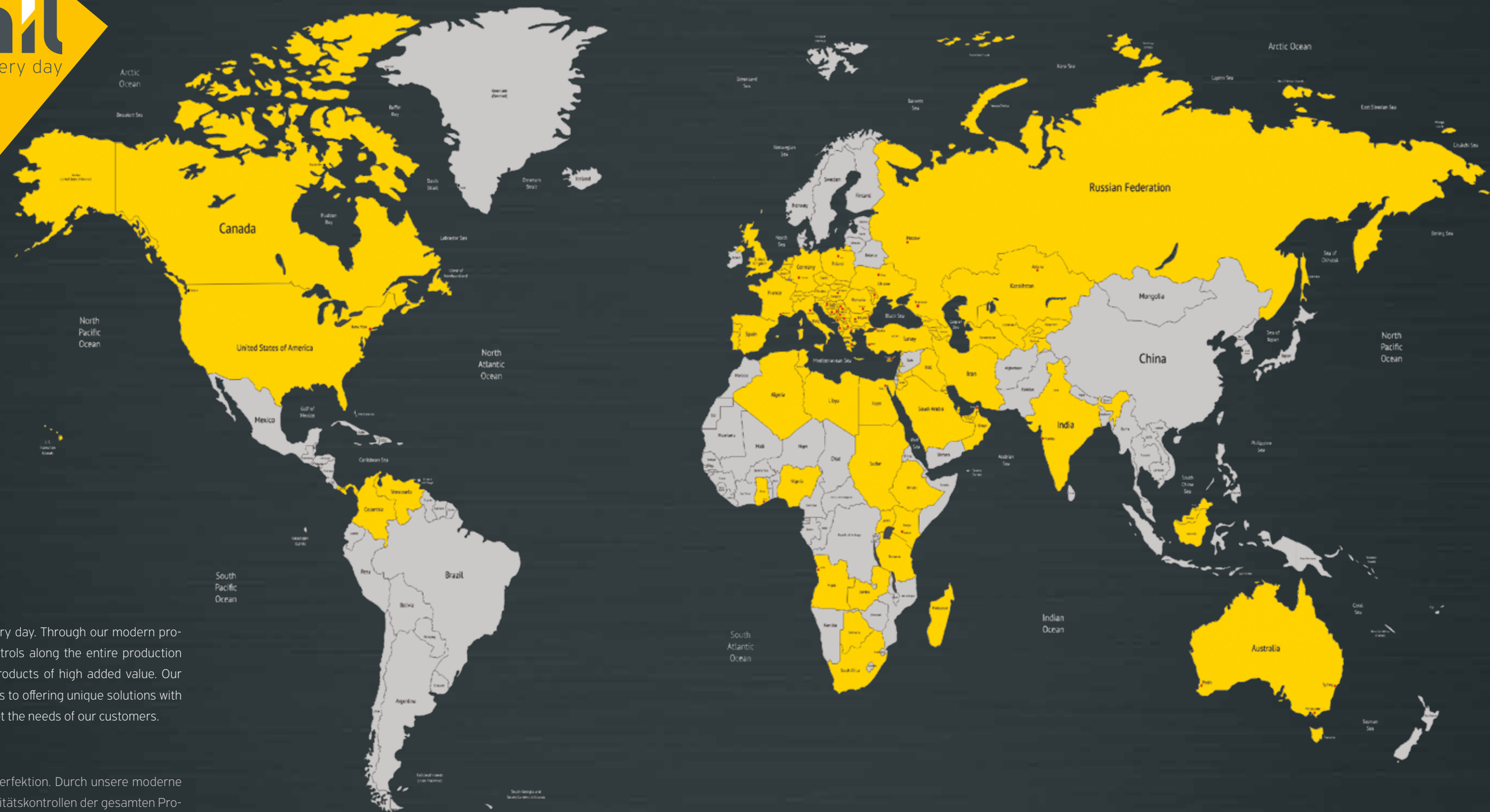

At **ALUMIL** we are building excellence every day. Through our modern production facilities and the strict quality controls along the entire production line, we ensure the creation of superior products of high added value. Our continuous research and development leads to offering unique solutions with many innovative features, which totally meet the needs of our customers.

Bei **ALUMIL** streben wir jeden Tag nach Perfektion. Durch unsere moderne Produktionsanlagen und den strengen Qualitätskontrollen der gesamten Produktionslinie entlang, sorgen wir für die Herstellung von qualitativen Produkten mit hohem Mehrwert. Unsere kontinuierliche Forschung und Entwicklung führt zu einzigartigen Lösungen mit vielen innovativen Eigenschaften, die vollständig die Bedürfnisse unserer Kunden befriedigen.

INDEX



page

10-15

1

WINDOW
HANDLES

FENSTERGRIFFE

page

22-27

3

ENTRANCE
DOOR
HANDLES

TÜRDRÜCKER

page

18-19

2

CREMONE
HANDLES

CREMONE
DREHFENSTERGRIFFE

page

30-35

4

CODE LIST

CODE LISTE



EN

With advanced industrial facilities of high standards and a strong international sales network in over 60 countries worldwide, with 32 subsidiaries across the globe, in all continents, ALUMIL is one of the top suppliers of architectural aluminium systems that meet the highest requirements and cover a very wide range of architectural needs.

Keeping our high standards of quality we worked along side with world leading companies specializing in handles to introduce our new Alumil Handles. The range covers all technical solutions with Alumil's patented design, offering a complete and unique identity to any project.

ALUMIL Handles main characteristics:

- / straight minimal lines offering a unique and a high aesthetic result
- / handles of same design covering all solutions in a uniform way
- / ALUMIL logo and unique design providing a distinctive identity of top quality
- / close cooperation with world-class manufacturers ensuring flawless operation, guaranteed
- / a "necessity" for ALUMIL outstanding SUPREME Systems

DE

Mit anspruchsvollen Produktionsanlagen und einem breiten internationalen Vertriebsnetz in über 60 Ländern mit 32 Tochtergesellschaften in der ganzen Welt auf allen Kontinenten, ist ALUMIL einer der erfolgreichsten Lieferanten von architektonischen Aluminium Systemen, die hohe Standards erfüllen und eine Vielzahl von architektonischen Anforderungen decken.

Unter Beibehaltung unserer hohen Standards in Bezug auf Qualität und in Zusammenarbeit mit weltweit führenden Unternehmen die sich auf Griffe spezialisieren, stellen wir Ihnen unsere ALUMIL Griffe vor. Wir bieten eine breite Auswahl an Griffen mit ALUMIL patentierten Design, die alle Bedürfnisse befriedigen und eine einzigartige Identität an jedes Projekt verleihen.

Haupteigenschaften der "ALUMIL GRIFFE":

- / Gerade Linien mit minimalistischen Design, die ein hohes aesthetisches Ergebnis anbieten
- / Konsistenz dank der gleichen Design-Logik für Griffe mit unterschiedlicher Funktionsweise
- / "ALUMIL Logo" und einzigartiges Design, das Ihren Systemen eine distinktive Identität in top Qualität verleiht
- / Kooperation mit Welt-Klasse Herstellern, so dass fehlerfreie Funktionalität geliefert und garantiert wird
- / Ein "Muss" für die hochwertigen SUPREME Systeme von ALUMIL



ALUMIL HANDLES

UNIQUE DESIGN
COMPLETE SOLUTION
SYSTEM IDENTITY



WINDOW
HANDLES

FENSTERGRIFFE

BEAUTY IN
SIMPLICITY

SCHÖNCHEIT
DURCH
EINFACHHEIT



WINDOW HANDLE WITH SPINDLE

Alumil window handle in minimal lines for tilt/turn and sliding systems. The patented Secustik® blocking mechanism provides integrated security if the handle is turned from the out side. Available in 25 and 38mm spindle length and paired for in/out application.

Available in all six standard colors.

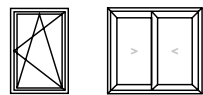

FENSTERGRIFF MIT VIERKANT

Fenstergriff mit 7mm Vierkant, entwickelt bei ALUMIL in minimalen Design, passend für Dreh- und Schiebefenster Systeme. Der patentierte Blockiermechanismus, Secustik® der in den Ovalrosetten installiert ist, bietet größere Sicherheit in dem er den Griff blockiert, wenn jemand versucht ihn von außen zu drehen.

Erhältlich mit 38mm und 25mm langem Vierkant und als Paar (innen/außen). Erhältlich in alle sechs Standardfarben.

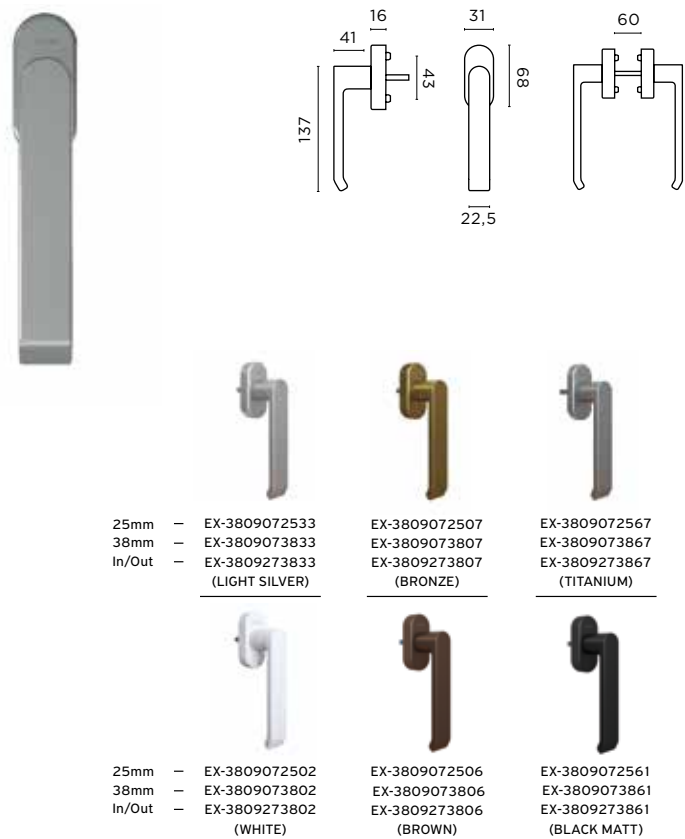

FULL METAL COVER HANDLE

Alumil window handle in minimal lines with a full metal cover for tilt/turn and sliding systems. The patented Secustik® blocking mechanism provides integrated security if the handle is turned from the out side. Available in 38mm spindle length.

Available in all six standard colors.

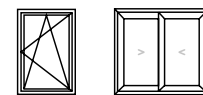

FENSTERGRIFF MIT VERDECKTEM GETRIEBE

Fenstergriff mit 7mm Vierkant, entwickelt bei ALUMIL, passend für alle Dreh- und Schiebefenster Systeme. Mit ovaler Rosette aus aluminium, die das ganze Secustik® Sperr-getriebe deckt.

Erhältlich in alle sechs Standardfarben.

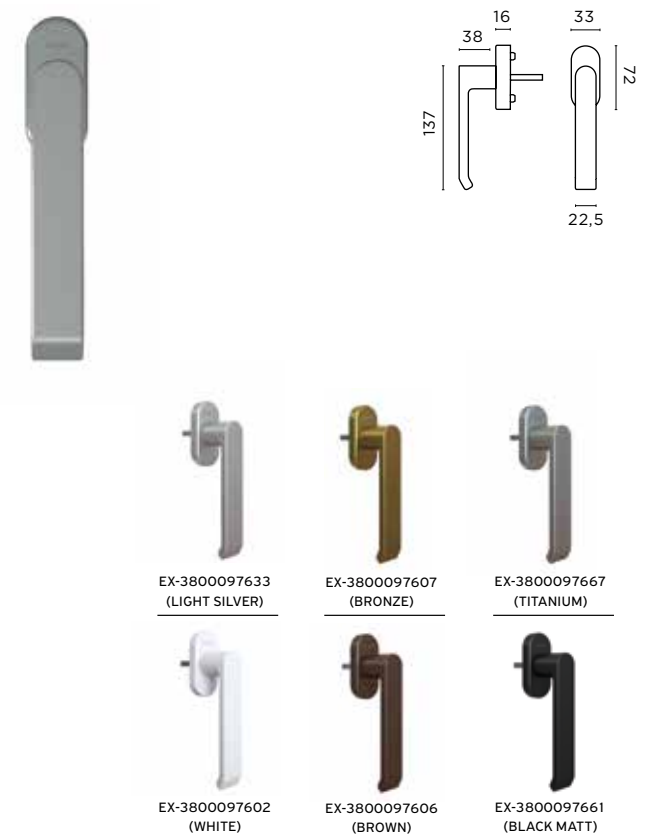

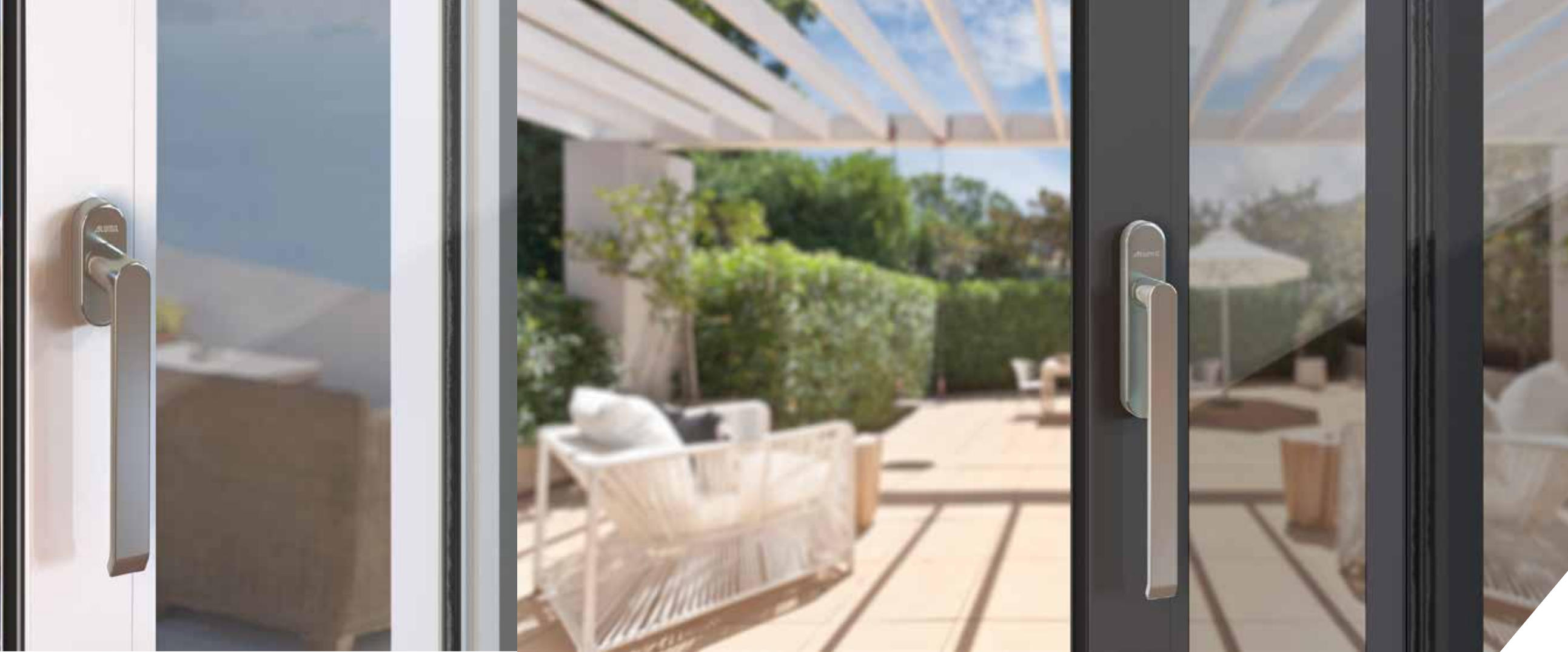

LONG WINDOW HANDLE

Alumil handle for lift & slide systems both as a single and a pair for in/out use. Flush handle 38054203 may be used with the single handle for pulling from the out side.

Available in all six standard colors.

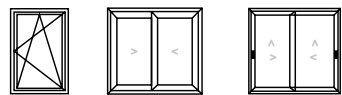

LANGER FENSTERGRIFF MIT VIERKANT

Fenstergriff größerer Länge (127mm) entwickelt bei ALUMIL. Passend für Grossformatige Drehfenster und leichte Schiebe und Hebeschiebe-Systeme. Mit Secustik Sperr-getriebe.

Erhältlich auch paarweise als Innen- und Außengriff oder passend dazu der Muschelgriff (EX-38054203)

Erhältlich in alle sechs Standardfarben

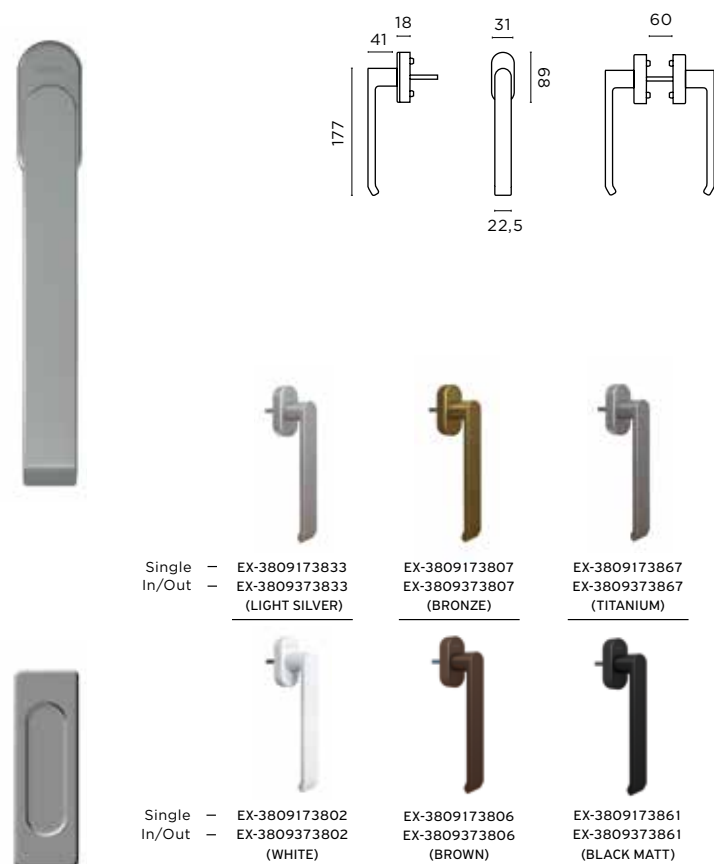

LIFT & SLIDE WINDOW HANDLE

ALUMIL handle with 10mm spindle, for lift & slide systems both as a single and as a pair for in/out use.

The single handle may be used with the flush which is available in two different depths, 7 and 11mm (EX-38054201, EX-38054202).

Available in all six standard colors.

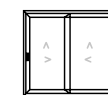

GRIF FÜR HEBE-SCHIEBETUREN

Griff mit 10mm Vierkant, für Hebe-Schiebesysteme, erhältlich auch paarweise als Innen- und Außengriff mit, oder ohne, äußeren Zylinderöffnung.

Der Griff kann mit den Muschelgriffen EX-38054201 (Tiefe 7mm) und EX-38054202 (Tiefe 11mm) kombiniert werden.

Erhältlich in alle sechs Standardfarben

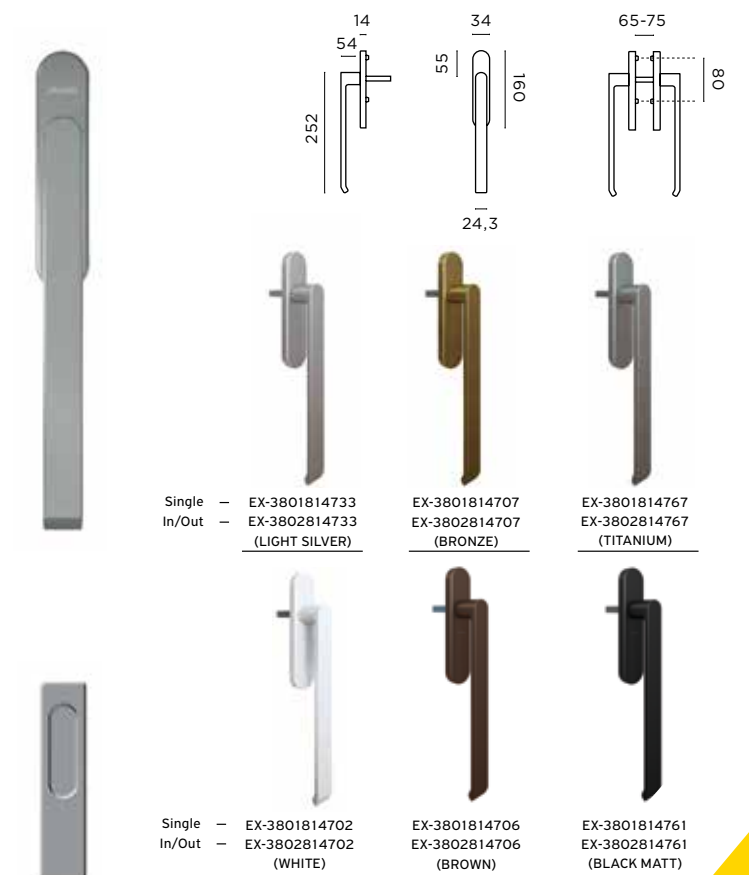



CRANKED WINDOW HANDLE WITH SPINDLE LEFT - RIGHT

Cranked handle with patented blocking mechanism **Secustik®** for integrated security. Elegant and ideal for sliding and façade windows especially when little space available for handling (e.g. S350).

Available in right and left version.
Available in four standard colors.

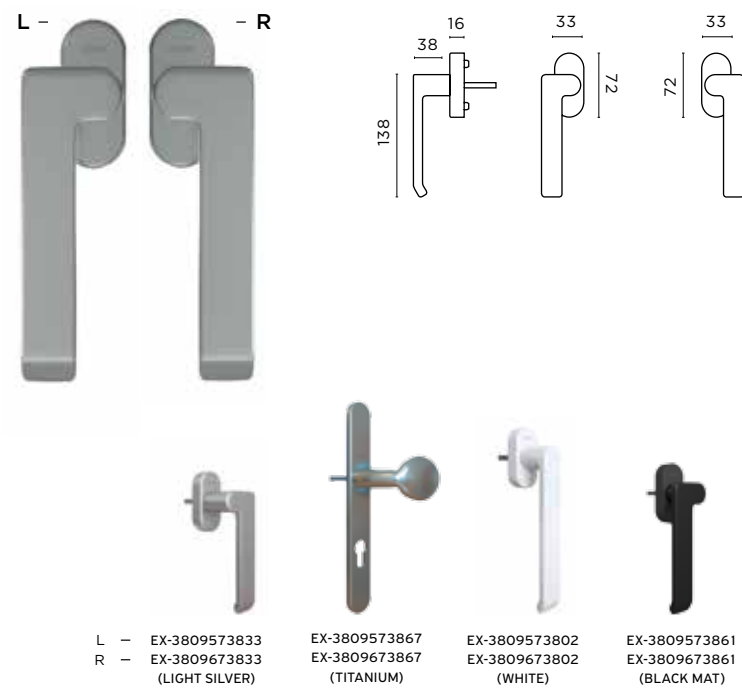
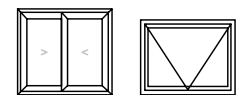

GEKRÖPFTER FENSTERGRIFF MIT VIERKANT

Griff in 'versetzter Form', mit Secustik Sperrgetriebe und ovaler Rosette, für integrierte Sicherheit. Ideal für Schiebe- und Ausstellfenster und überall dort wo Platzmangel für die Hände herrscht.

Erhältlich als Rechts- oder Linksgriff.
Erhältlich in vier Standardfarben.

SPECIAL WINDOW HANDLE WITHOUT ROSETTE

An Alumil handle without rosette offering minimal aesthetics to any tilt & turn or opening window.

Available in three standard colors.

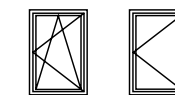

FENSTERGRIFF OHNE ROSETTE

Fenstergriff ohne Rosette für Dreh- und Drehkipfenster. Minimal Design mit sehr einfacher Montage. Erhältlich in drei Standardfarben.

Erhältlich in drei Standardfarben

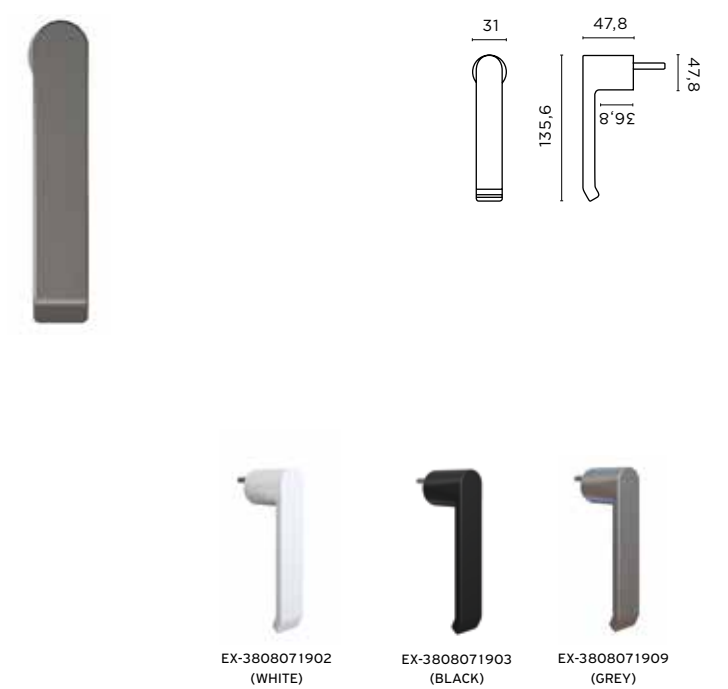



CREMONE
HANDLES

CREMONE
FENSTERGRIFFE

STYLE
YOU CAN
FEEL

STIL DEN
SIE FÜHLEN
KÖNNEN



CREMONE HANDLE FOR SIDE-HUNG

The Alumil Cremone Handle for side hung windows. Part of our patented design along with the other handles.

Available in three standard colors.



KREMONE GRIFF FÜR DREHFENSTER

Drehfenstergriff für Fenster ohne Kippfunktion. Im gleichen Design mit den anderen Alumilgriffen.

Erhältlich in drei Standard Farben.

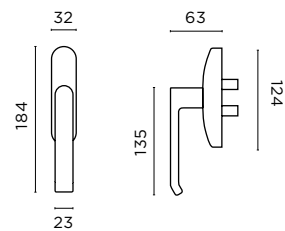

CREMONE HANDLE FOR TILT & TURN

The Alumil Cremone Handle for tilt and turn windows. Part of our patented design along with the other handles.

Available in three standard colors.



KREMONE GRIFF FÜR DREHFENSTER MIT KIPPFUNKTION

Drehfenstergriff für Fenster mit Kippfunktion (für Giesse und GU-Beschläge). Im gleichen Design mit den anderen Alumilgriffen.

Erhältlich in drei Standard Farben.

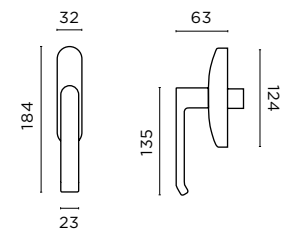

A photograph of a modern entrance door with a large yellow diagonal graphic overlay. The door is light-colored and partially open, revealing a dark interior. The surrounding architecture features a mix of light-colored stone and brickwork. The scene is set outdoors with a paved area and some furniture visible in the background.

**ENTRANCE
DOOR
HANDLES**

**GRIFFE
FÜR
EINGANGSTÜREN**

**ELEGANCE
AT FIRST
SIGHT**

**ELEGANZ
AUF DEN
ERSTEN
BLICK**



ENTRANCE DOOR HANDLE SET

Minimal entrance door set with separate narrow rosette and 8mm spindle.

In complete alignment with ALUMIL design and available in all six standard colors.

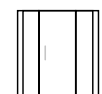
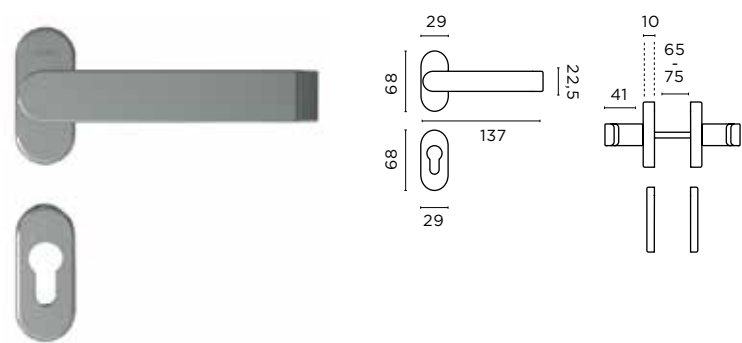

TÜRDRÜCKER SET MIT ROSETTE

Türdrücker Innen/Außen, mit 8mm Vierkant, minimal Design und flacher Rosette. In gleicher Form mit allen Alumilfenstergriffen. Erhältlich in alle sechs Standardfarben.



SPINDLE FOR WIDER SASHES

Longer spindles for wider sash applications, i.e. for M11500 and SD95

EX-3804682700
8x170mm M11500
-
EX-3804683500
8x190mm SD95

VIERKANTSTIFTE FÜR BREITERE PROFILE

Im Falle sehr breiter Profile sind Vierkantstifte mit entsprechender Länge erhältlich, z.B. für die Alumilsysteme M11500 und SD95.

EXPANSION SPINDLE FOR SINGLE HANDLE

When the handle is to be used only on one side, expansion spindles are available as well as additional escutcheons (EX-38022321).

EX-3801853100
8x65mm
-
EX-3801855500
8x75mm
-
EX-3807196700
8x85mm

VIERKANT FÜR EINSEITIGE TÜRDRÜCKER

Für einseitige Türdrücker sind die längeren Vierkantstifte und die dazupassende Rosetten als extras erhältlich (EX-38022321).



ENTRANCE DOOR HANDLE ON PLATE

Entrance door handle with 8mm spindle and full body rosette. Part of our patented Alumil Design range.

It comes both as a pair and as a single handle. Available in all six standard colors.

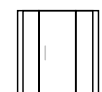
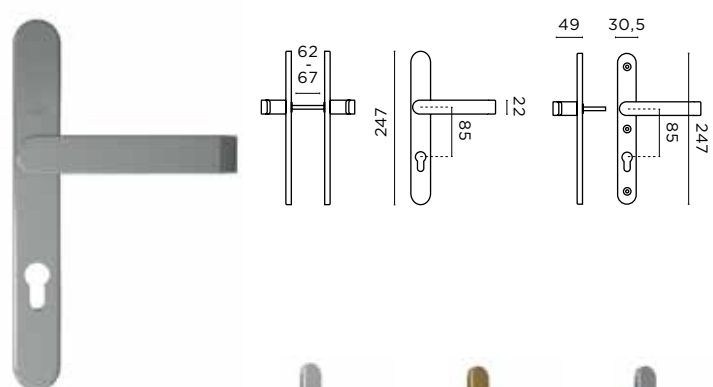

TÜRDRÜCKER MIT LANGSCHILDROSETTE

Türdrücker mit Langschildrosette, mit 8mm Vierkant und und einen Zylinder/Vierkant Maß von 85mm. Design in Übereinstimmung mit allen ALUMIL's gebrandmarkten Griffen

Erhältlich auch allein, als einzel Türdrücker
Erhältlich in alle sechs Standardfarben.



ENTRANCE DOOR HANDLE WITH FIXED KNOB

Entrance door Alumil Handle with 8mm spindle and a fixed outside knob. Part of our patented Alumil Design range.

85mm handle-key hole distance. Available in four standard colors.

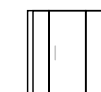
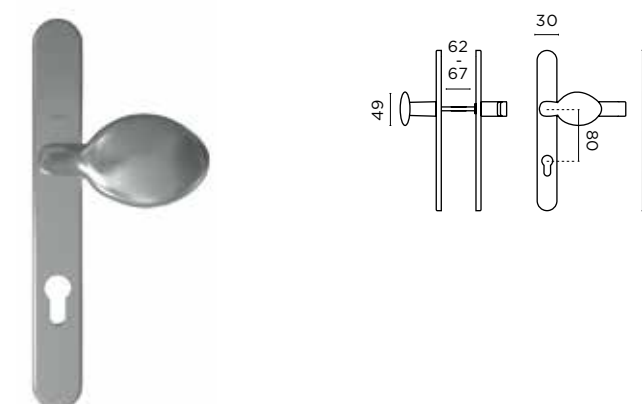

FESTER TÜRDRÜCKER

Türäußengriff mit 8mm Vierkant und mit festem Griff an der Aussenseite. Mit einen Zylinder/Vierkant Maß von 85mm.

Erhältlich in vier Standardfarben.





CRANKED ENTRANCE DOOR HANDLE

Cranked entrance door handle suitable for outwards opening applications. Special design providing additional space for handling and in compliance with safety specifications.

It is offered as a single handle, with a separate ((EX-38097711)) escutcheon. Spindles in various lengths are available. Available in four standard colors.

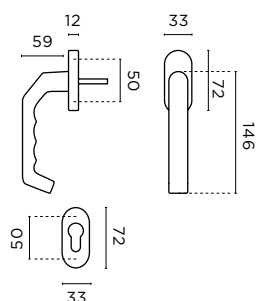
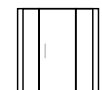

TÜRDRÜCKER MIT GEKRÖPFTEM GRIFF

Eingangstür Griff mit gekröpfter Form, ideal für auswärtsöffnende Türen. Spezielles Design das mehr Platz für die Hände bietet.

Erhältlich allein als einzel Griff, separate Rosette und Vierkant in verschiedenen Längen.

Erhältlich in vier Standardfarben.



INTERIOR DOOR HANDLE SET

Interior door handle set with ALUMIL's elegantly simple Design, ideal for INTERNO's modern door solutions.

With round rosette and escutcheon, in alignment with the complete range of our branded handles.

Available in two standard colors.

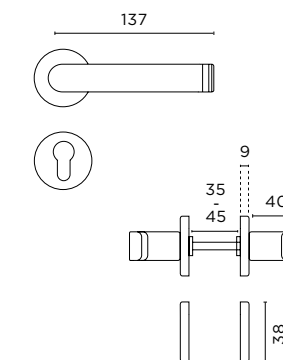
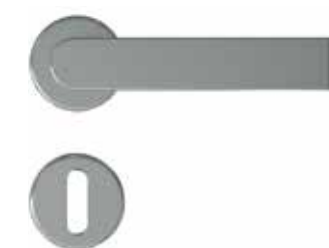

INNENTÜRDRÜCKER PAAR

Innentürdrücker Set mit ALUMIL's eleganten Design, ideal für INTERNO's modernen Tür Lösungen.

Erhältlich auch mit runder Rosette und Escutcheon, in Übereinstimmung mit allen unserer gebrandmarkten Griffen.











Erhältlich in zwei Standardfarben.





CODE LIST
CODE LISTE

STANDARD WINDOW HANDLES

	CODE	DESCRIPTION	APPLICATION	CHARACTERISTICS	FINISHING	PAGE
Fenstergriffe Mit Vierkant						
	EX-38090725	Window Handle With Spindle Fenstergriff Mit Vierkant	Hinged - Tilt & Turn Slide	Spindle 7/25mm Vierkant 7/25mm	6	10
	EX-38090738	Window Handle With Spindle Fenstergriff Mit Vierkant	Hinged - Tilt & Turn Slide	Spindle 7/38mm Vierkant 7/38mm	6	10
	EX-38092738	In/Out Window Handle Set Paar Innen-Außengriff	Hinged - Tilt & Turn Slide	In/Out, Spindle 7/60mm Paar, Vierkant 7/60mm	6	10
Fenstergriff Mit Verdecktem Getriebe						
	EX-38000976	Window Handle With Spindle Vollmetall Fenstergriff mit Vierkant	Hinged - Tilt & Turn Slide	Full Metal Cover, Spindle 7/38mm Vollmetall, Vierkant 7/38mm	6	11
Lange Fenstergriffe						
	EX-38091738	Long Window Handle Lang Fenstergriff Mit Vierkant	Hinged - Tilt & Turn Slide - Lift & Slide	177mm Length, Spindle 7/38mm 177mm Lange, Vierkant 7/38mm	6	12
	EX-38093738	Double Window Handle With Spindle Paar Lang Fenstergriff Mit Vierkant	Hinged - Tilt & Turn Slide - Lift & Slide	In/Out, 177mm Length, Spindle 7/60mm Paar, 177mm Lange, Vierkant 7/60mm	6	12
	EX-38054203	Flush Handle Muschelgriff	Slide - Lift & Slide	43mm, 90Kg	6	12
Hebe-Schiebenturengriff und Muschelgriffen						
	EX-38018147	L&S Window Handle Hebe-Schiebeturen Griff	Lift & Slide	Spindle 10mm, 80mm 10mm Vierkant, 80mm	6	13
	EX-38028147	In/Out L&S Window Handle Paar Hebe-Schiebeturen Griff	Lift & Slide	Cylinder Hole, Spindle 10/65-75mm Zylinder, Vierkant 10/65-75mm	6	13
	EX-38054201	Flush Handle Muschelgriff	Lift & Slide	7mm Depth, 80mm 7mm Tiefe, 80mm	6	13
	EX-38054202	Flush Handle Muschelgriff	Lift & Slide	11mm Depth, 80mm 11mm Tiefe, 80mm	6	13

		CODE	DESCRIPTION	APPLICATION	CHARACTERISTICS	FINISHING	PAGE
Fenstergriffe Mit Versetzter Grifffläche		EX-38095738	Cranked Window Handle Gekröpfter Fenstergriff	Top Hung - Slide	Left, Spindle 7/38mm Links, 7/38mm Vierkant	4	14
		EX-38096738	Cranked window Handle Gekröpfter Fenstergriff	Top Hung - Slide	Right, Spindle 7/38mm Rechts, 7/38mm Vierkant	4	14









Special Window Handle Without Rosette

Spezial Griff Fur Drehkipfenster Ohne Rosette		EX-38080719	Special Handle Without Rosette Spezial Fenstergriff Ohne Rosette	Side-Hung Tilt & Turn	Without Rosette, Special Transmission Gear Ohne Rosette, Spezial Getriebe	3	15
--	---	-------------	---	--------------------------	---	---	----

CREMONE HANDLES

		CODE	DESCRIPTION	APPLICATION	CHARACTERISTICS	FINISHING	PAGE
Cremone Handle For Hinged							
Cremone Fenstergriffe		EX-38024470	Cremone Handle For Side-Hung Cremonegriff Für Drehfenster	Side-Hung	-	3	18
		EX-38024810	Tilt & Turn Cremone Handle Cremonegriff Für Dreh-Kipfenster	Tilt & Turn	GU hardware GU Beschlag	3	19

DOOR HANDLES

	CODE	DESCRIPTION	APPLICATION	CHARACTERISTICS	FINISHING	PAGE
Türdrücker Mit Rosette						
	EX-38097610	Door Handle With Separate Rosette Türdrücker Mit	Entrance Door	In/Out, Spindle 8/65-75mm Innen-Aussen, Vierkant 8/65-75mm	6	22
	EX-38022321	EX-38097610 Rosette Rosette Für EX-38097610	Entrance Door	29x68mm	6	23
Türdrücker Mit Langschildrosette						
	EX-38097880	Door Handle On Backplate Türdrücker Mit Langschild	Entrance Door	In/Out, Spindle 8/62-67mm Paar, Vierkant 8mm	6	24
	EX-38097881	Door Handle On Backplate Türdrücker Mit Langschild	Entrance Door	Single, Spindle 8mm Einzel, Vierkant 8mm	6	24
Türdrücker Festem Griff An Der Aussenseite						
	EX-38097882	Door Handle With Fixed Knob Türdrücker Mit	Entrance Door	In/Out, Spindle 8/62-67mm Innen-Aussen, Vierkant 8/62-67mm	4	25
Türdrücker Mit Gekröpftem Griff						
	EX-38097710	Cranked Door Handle Gekröpfter Türdrücker	Entrance Door	Single, cranked, spindle 8mm Einzel, gekröpfter, Vierkant 8mm	6	26
	EX-38097711	EX-38097710 rosette Rosette Für EX-38097710	Entrance Door	33x72mm	6	26
Innentürdrücker						
	EX-38098680	Interior Door Handle Innentürdrücker Paar	Interior	In/Out, Spindle 8mm Innen-Aussen, Vierkant 8mm	2	27

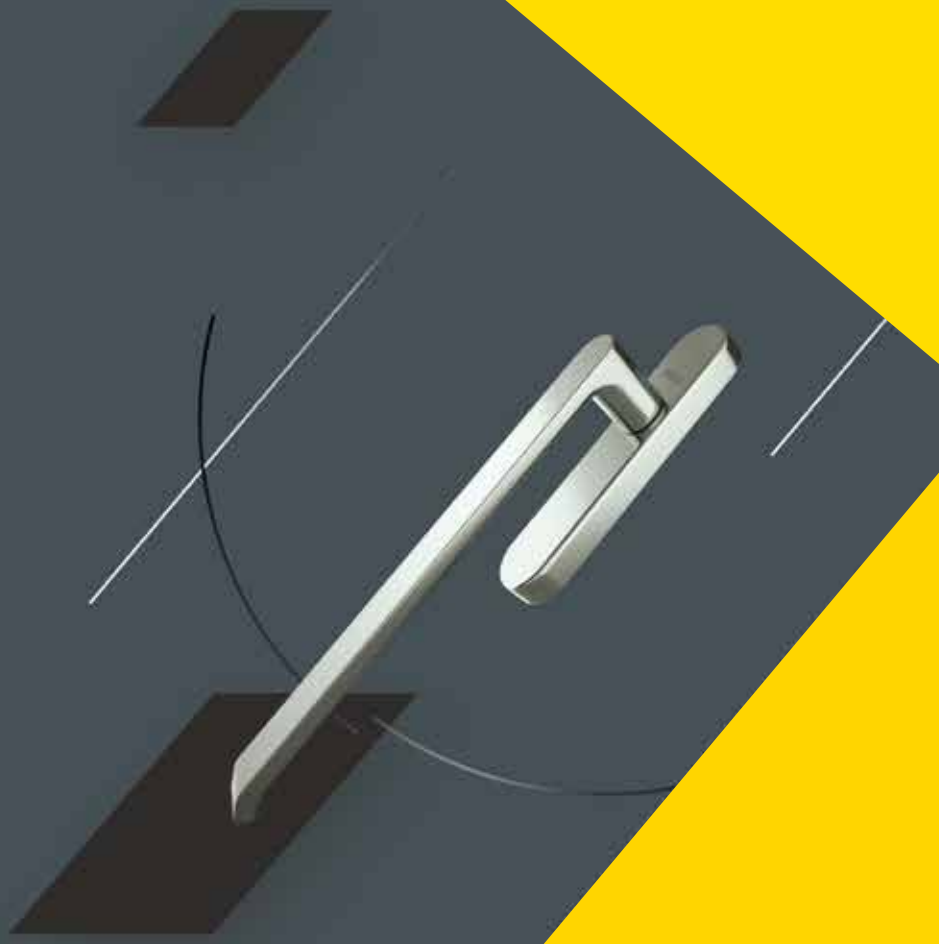

Alumil
Building excellence every day

ALUMIL DEUTSCHLAND GMBH

Wingert Str. 21
D-64354 Reinheim
Tel.: +49 6162 9688770
Fax: +49 6162 9688775
www.alumil.com
E-mail: info@alumil.de

**HEADQUARTERS & FACTORY
KILKIS INDUSTRIAL AREA**

Kilkis - GR 611 00
Tel.: +30 23410 79300
Fax: +30 23410 71988
E-mail: info@alumil.com

**HEAD OFFICES
& SHOWROOM - THESSALONIKI**

Gogousi 8, Efkarpia
Thessaloniki - GR 564 29
Tel.: +30 2313 011000
Fax: +30 2310 692473
E-mail: info@alumil.com

alumil

www.alumil.com