



**Alumil**  
Building excellence every day

**Alumil**  **SUPREME**  
**S500 PHOS**



# CONTENTS

## **SUPREME S500**

OVERVIEW	2
DESIGN PHILOSOPHY AND KEY FEATURES	4
SENSE OF FREEDOM	8
THE ULTIMATE MINIMAL DESIGN	10
DEFYING GRAVITY: THE REVOLUTION IN WINDOWS TECHNOLOGY	12
ATTENTION TO DETAIL	14
FOCUS ON SAFETY	16
SECTIONS	20
INSTALLATION	30
APPLICATIONS	38
TABLE OF PERFORMANCE	39



The **SUPREME S500 PHOS** sets new standards for minimalism with its clear, symmetrical lines, impressive functionality and implementation of advanced technology.

**PHOS** means **LIGHT**

*"Light is not so much something that reveals, as it is itself the revelation."*

# The Art of Luxury Living

**Alumil** SUPREME  
S500 PHOS

Discover perfection in ALUMIL's  
**thermally insulated** sliding system  
**SUPREME S500 PHOS,**

## DESIGN PHILOSOPHY

where **minimalist aesthetics** combine with  
**exceptional functionality.**

## AND KEY FEATURES

- **Patented magnetic technology** for sliding aluminium systems offers limitless dimensions and typologies using the version **SUPREME S500 SlideAir**.
- Guaranteed ease in sliding sashes weighing up to 1 000 Kg, without the need for power supply or additional space to install magnetic technology.
- Certified durability, delivering unmatched resilience in highly corrosive environments.
- Minimal design with concealed profiles and clear, symmetrical lines for maximum natural light.
- Narrow interlocking profile of only 25 mm face width for unobstructed views.
- Easy and safe access with the **Eclipse version**, with a fully concealed bottom track covered with the floor finish, providing a flat surface.
- Ultimate minimal design in the **Total Eclipse version**, with all tracks covered by the ceiling, floor, and walls, resulting in a seamless appearance.



**Alumil** SUPREME  
S500 PHOS



## TECHNICAL

## CHARACTERISTICS

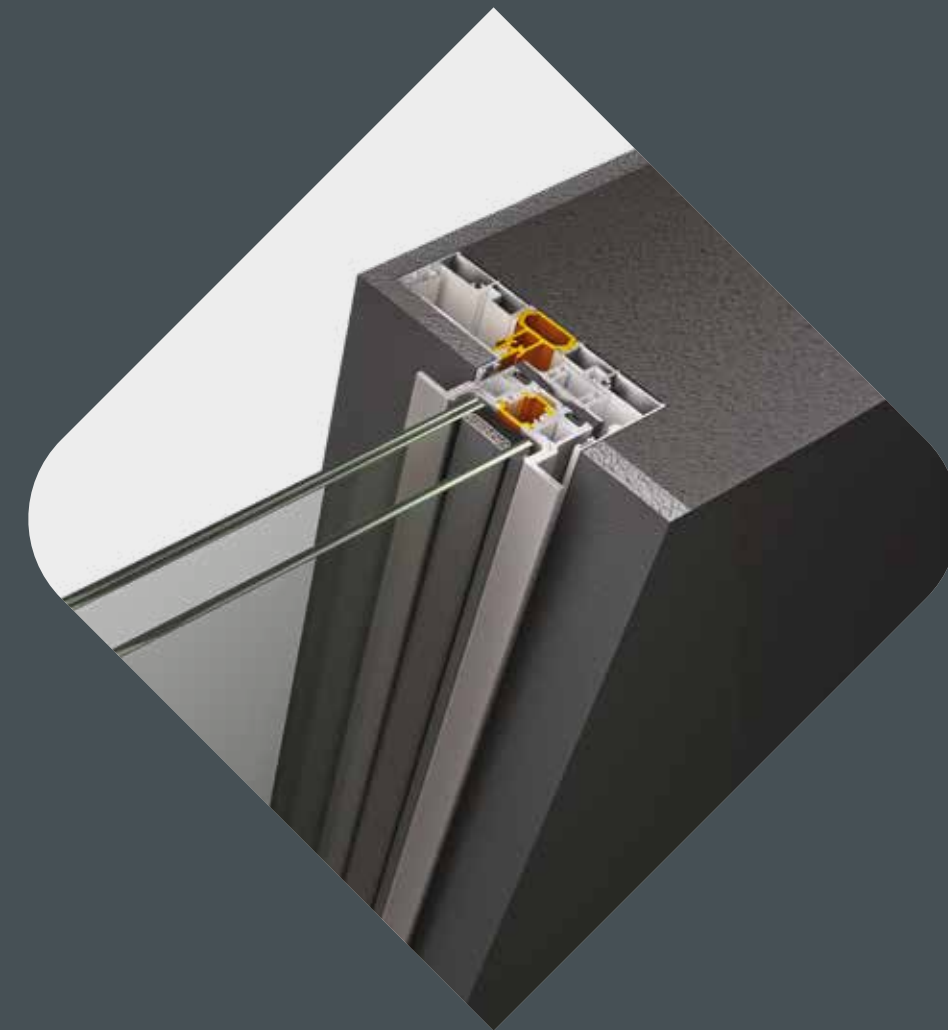

VISIBLE ALUMINIUM FACE WIDTH	29 mm
FRAME HEIGHT	103 mm
FRAME WIDTH	210 mm
SASH HEIGHT	29 / 32 mm
SASH WIDTH	50 mm
INTERLOCKING PROFILE WIDTH	25 mm
SASH WEIGHT	1000 Kg
GLAZING	36-40 mm
INSULATION	POLYAMIDES, ABS

**Alumil** > SUPREME  
S500 PHOS

Enjoy an  
**unobstructed view** and  
abundant **natural light**

with just **25mm** of visible  
aluminium at the interlocking profile.

The system presents a **symmetrical view** of aluminium around the glazing panel, featuring a similar width to the interlocking profile. This enhances uniformity in appearance, elevating any space's overall elegance and aesthetic appeal.



**Alumil** SUPREME  
S500 ECLIPSE

In the **Eclipse version**, the bottom track is recessed into the floor, fully covered by the floor finish. This design creates a flat surface that ensures effortless and secure access while establishing a seamless connection between indoor and outdoor spaces.

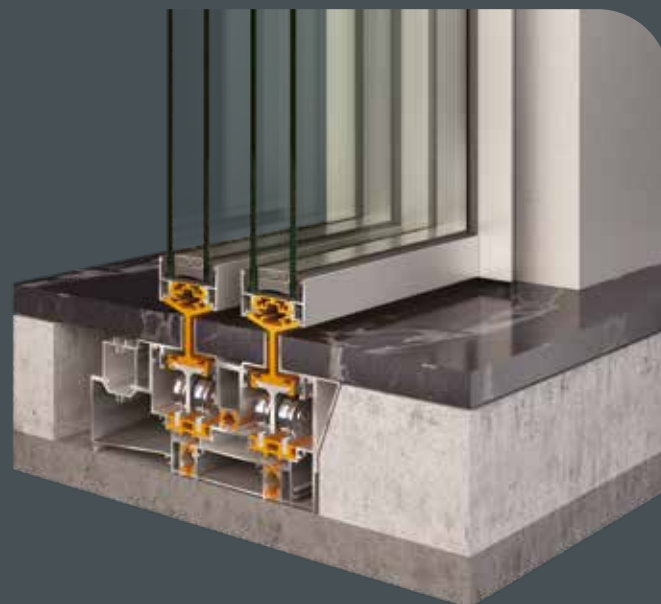

THE ULTIMATE

MINIMAL DESIGN

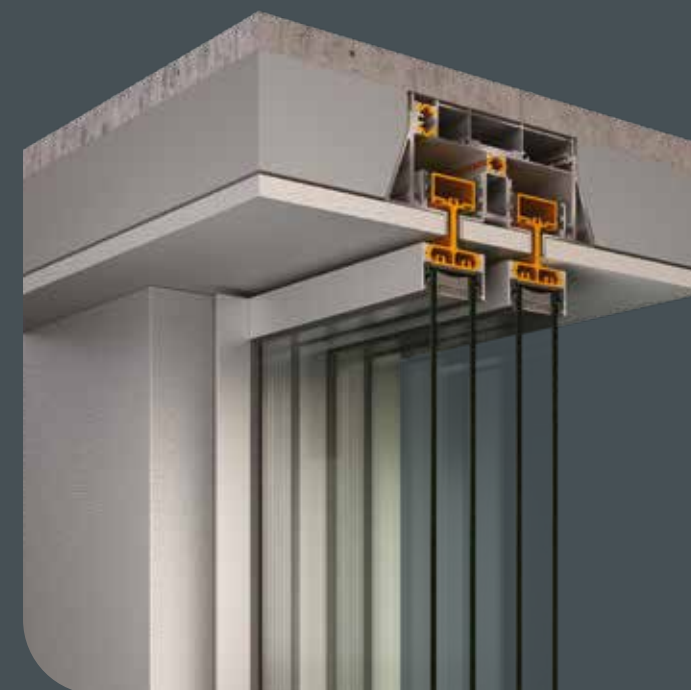

For those who crave the purest form of minimalism, the **Total Eclipse version** eliminates any visible tracks in a closed position. Even the top and side tracks are cleverly hidden within the ceiling and the wall finish, enhancing the overall aesthetics.

**Alumil** > SUPREME  
S500 SlideAir

Experience ultimate ease in operation with the **SUPREME S500 SlideAir™** version.

## DEFYING GRAVITY:

## THE REVOLUTION IN WINDOWS TECHNOLOGY

The revolutionary design with patented **magnetic technology** offers **effortless gliding** of the sashes.



This technology can apply to any project using the **same profiles as the standard version**. The technology offers **endless design possibilities** without constraints on sash dimensions, aligning with contemporary project demands and individual preferences. To apply the technology, **no power supply is required**.

The state-of-the-art technology, along with the expertise of Alumil, guarantees **high-quality constructions** through easy and safe installation.





**Alumil** SUPREME  
S500 PHOS



## ATTENTION

The specially designed **fiberglass-reinforced polyamides** for sash and track profiles deliver **exceptional thermal insulation** performance.

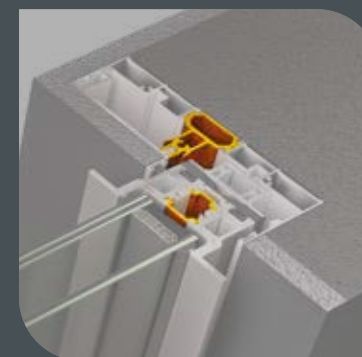

The innovative design of the **sash base fiberglass-reinforced polyamide** ensures thermal break between indoors and outdoors and guarantees outstanding material durability.



The specially designed **glass setting blocks** offer stability and balance to the glazing panel while making the fabrication easier and faster.



Including **sash gaskets on the locking side of the sash** enhances sealing performance and is also used as a shock absorber during closer.



## TO DETAIL

The ingenious design of the **upper sash polyamide** (Total Eclipse version) contributes to the stability and alignment of the sash.

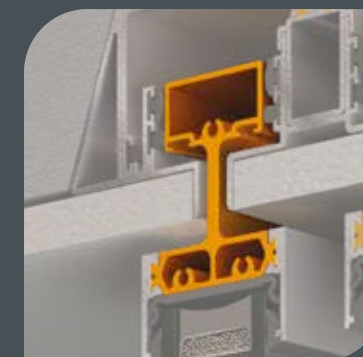

The environmentally friendly profiles, made of **durable thermoplastic material**, contribute to superior thermal insulation at the interlocking profile.



The addition of **sash spacers at the upper track** contributes to the alignment of the sliding sash for flawless operation.

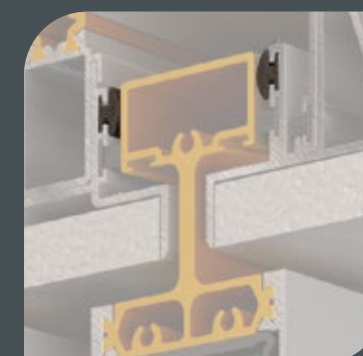

**High-quality brushes**, in standard and tri-fin versions around the sash perimeter, elevate air permeability and watertightness.

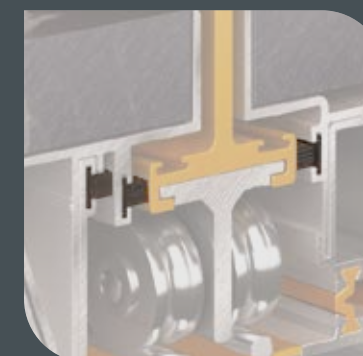

**Alumil** > SUPREME  
S500 PHOS

## FOCUS

## ON SAFETY

### Locking system

The Alumil-designed **locking system guarantees elevated security** during operation through the incorporation of several key features:

- Multiple locking points for enhanced security.
- Stainless steel adjustable locking pin heads for flexibility and durability.



- Wrong operation safety device for preventing misuse and improper operation.
- Soft close device for a gentle, secure and noiseless closure of the sashes.

The locking mechanism is tested in a **durability test for 20.000 cycles** and a **mishandling test for 20.000 cycles**.

### Handles

The **full-height profile handle** not only offers a symmetrical, clean-lined appearance that enhances the overall aesthetics but also a comfortably sized surface for effortless grasping and smooth sash operation.

The **Alumil-designed locking controller**, with the same finish as the profiles, is discreetly integrated into the handle profile. In the closed position, it aligns perfectly with the straight lines of the design, creating a seamless and elegant appearance. Moreover, the controller can be easily detached for maintenance.

**Alternative version:** Flawless aesthetics maintained with the minimal lock handle on the narrow 25 mm interlocking profile.

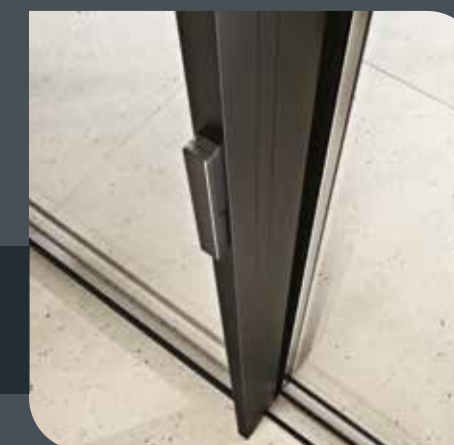

**Alumil** SUPREME  
S500 PHOS

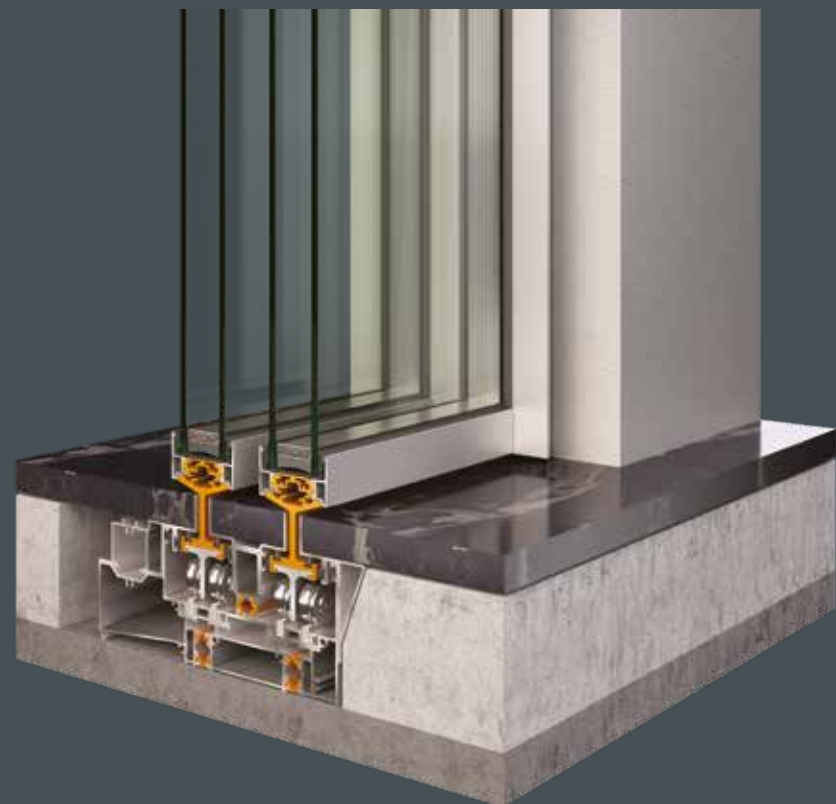

## Rollers & Inox Guide Rail

The heavy-duty **inox guide rail** (AISI 316L), in cooperation with the **stainless-steel rollers** placed under the sash, ensures exceptional functionality and long-lasting performance. The middle part of the bottom track is conveniently removable to allow access to the rollers in case of maintenance.

The rollers are engineered for heavy-duty constructions up to 1000 Kg per sash and have certified performance, tested according to EN 13126-15 and EN 1670 for corrosion resistance and durability.

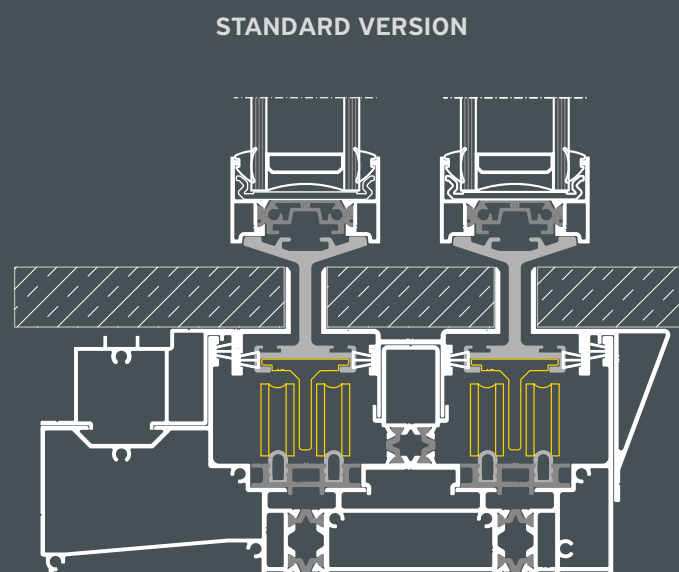

## FOCUS

## ON SAFETY

### SlideAir™ Technology

The **magnetic suspension** is achieved through **magnets** placed under the sash. The magnetic field is totally confined inside the magnet section, eliminating external magnetic dispersions.

The patented magnetic technology:

- guarantees operational force of **2 Kg for sash weight 600Kg**
- provides corrosion resistance in salt spray environment
- is tested for durability in cycling test

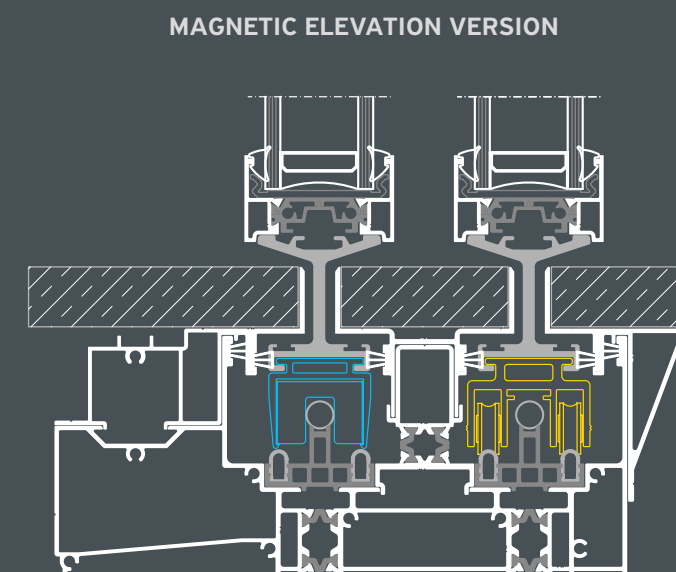

With the **magnetic elevation**, the rollers and magnets cooperate to support the full weight of the sash, offering **easy operation even for very heavy sashes**.

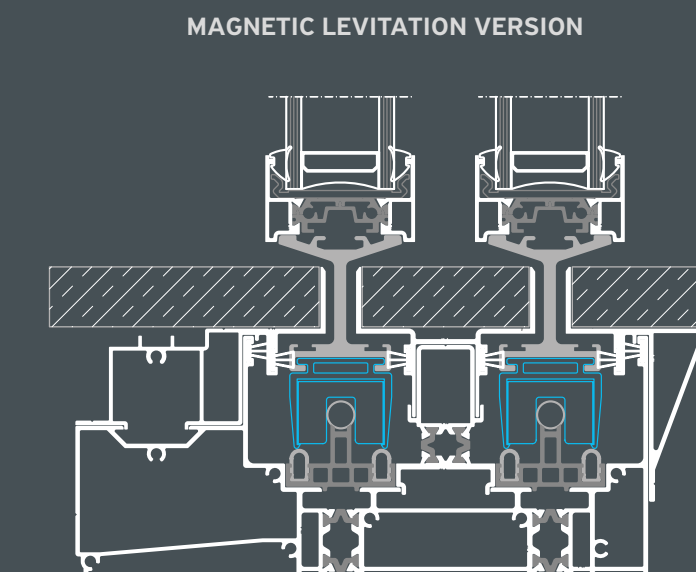

With **magnetic levitation**, the magnets fully support the weight of the sash, ensuring **smooth operation** and **long-lasting functionality**, even in highly corrosive environments.

### 2 Sashes / 2 Track

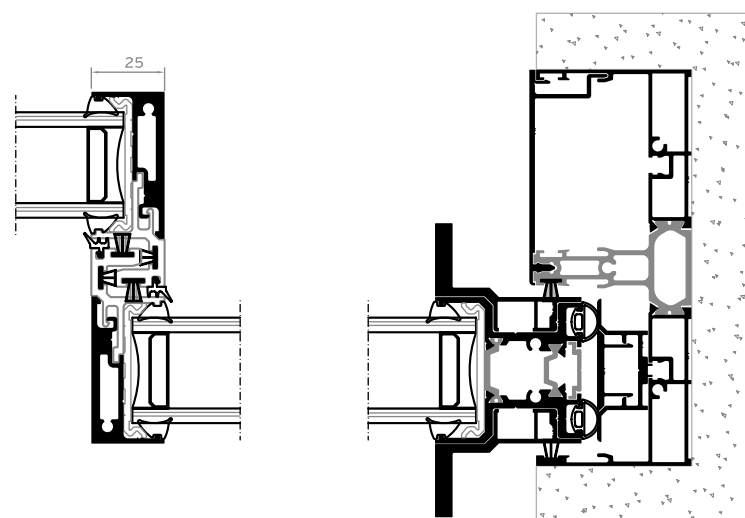
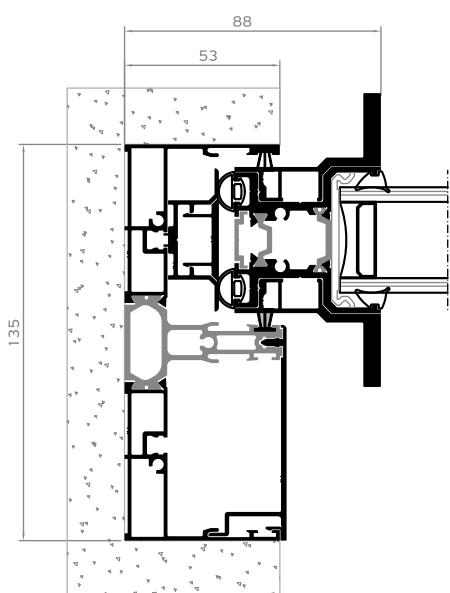
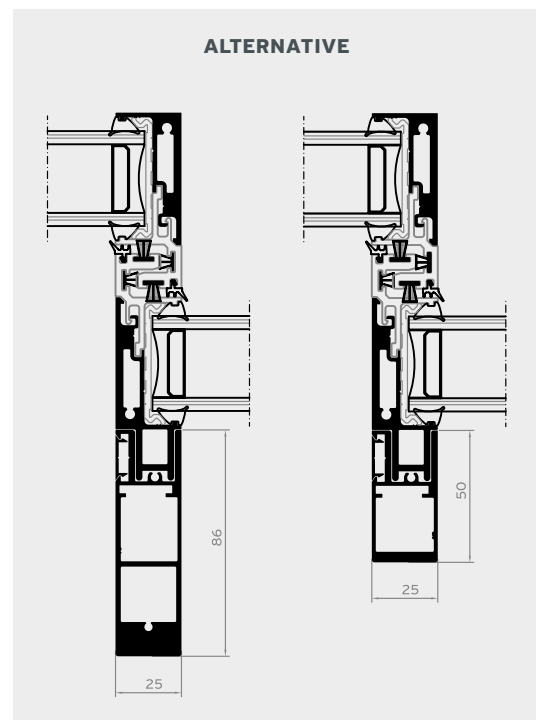
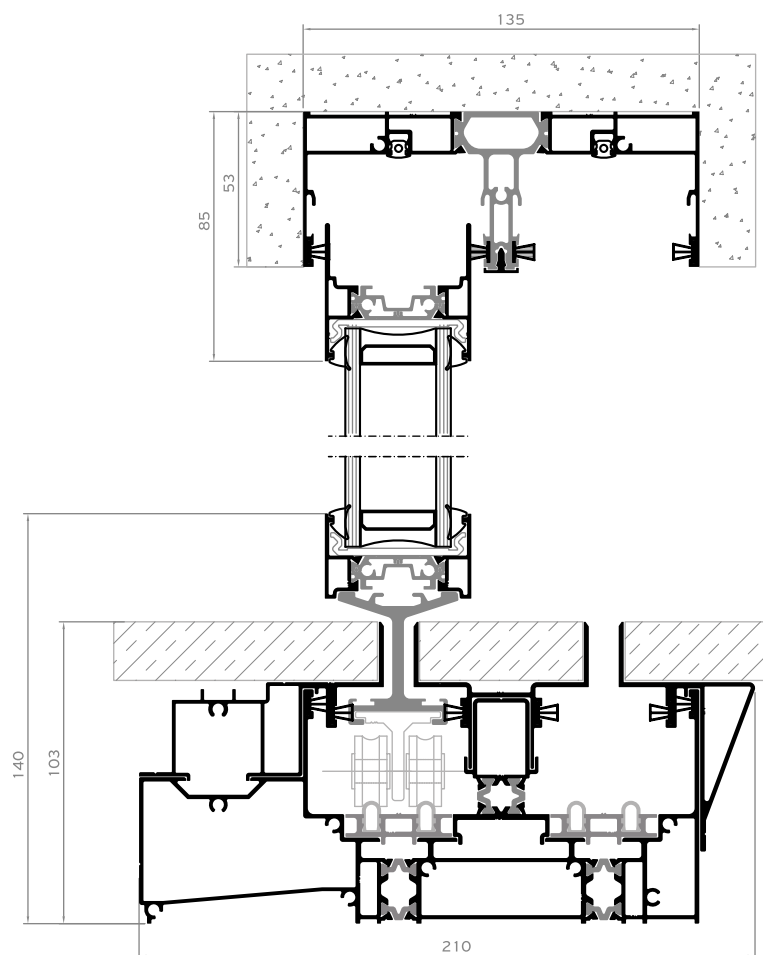
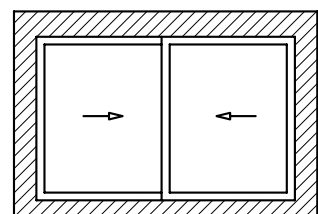

### 2 Sashes / 2 Track / Total Eclipse

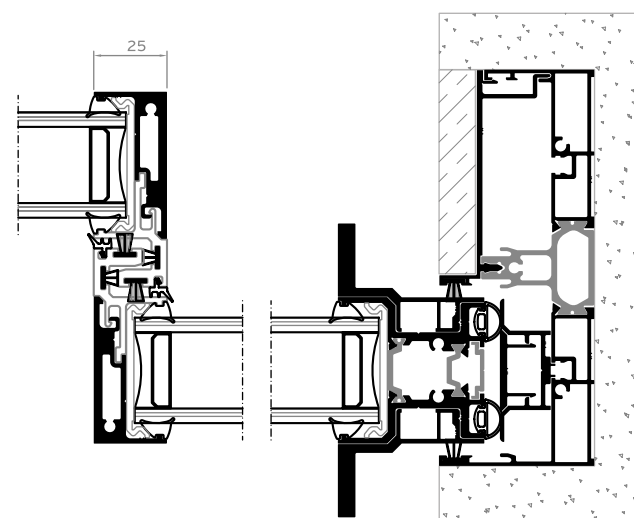
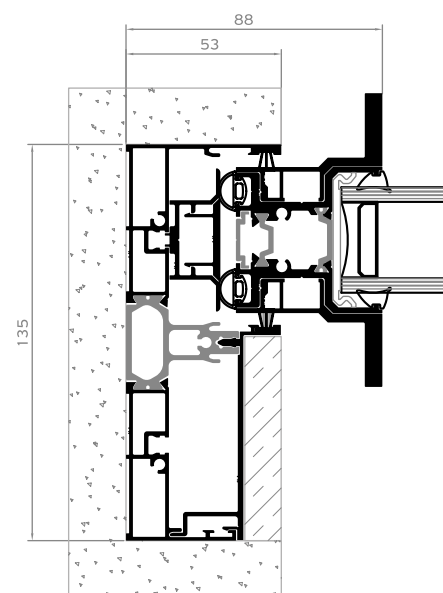
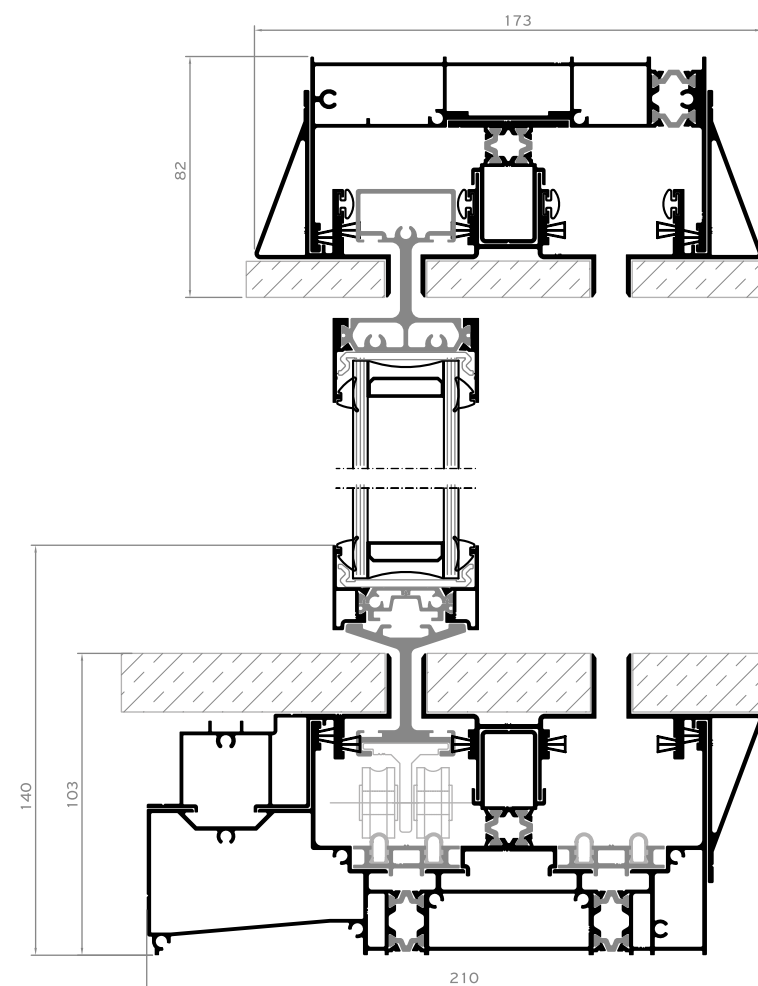
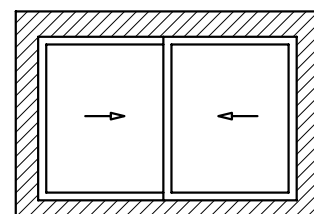

3 Sashes / 3 Track

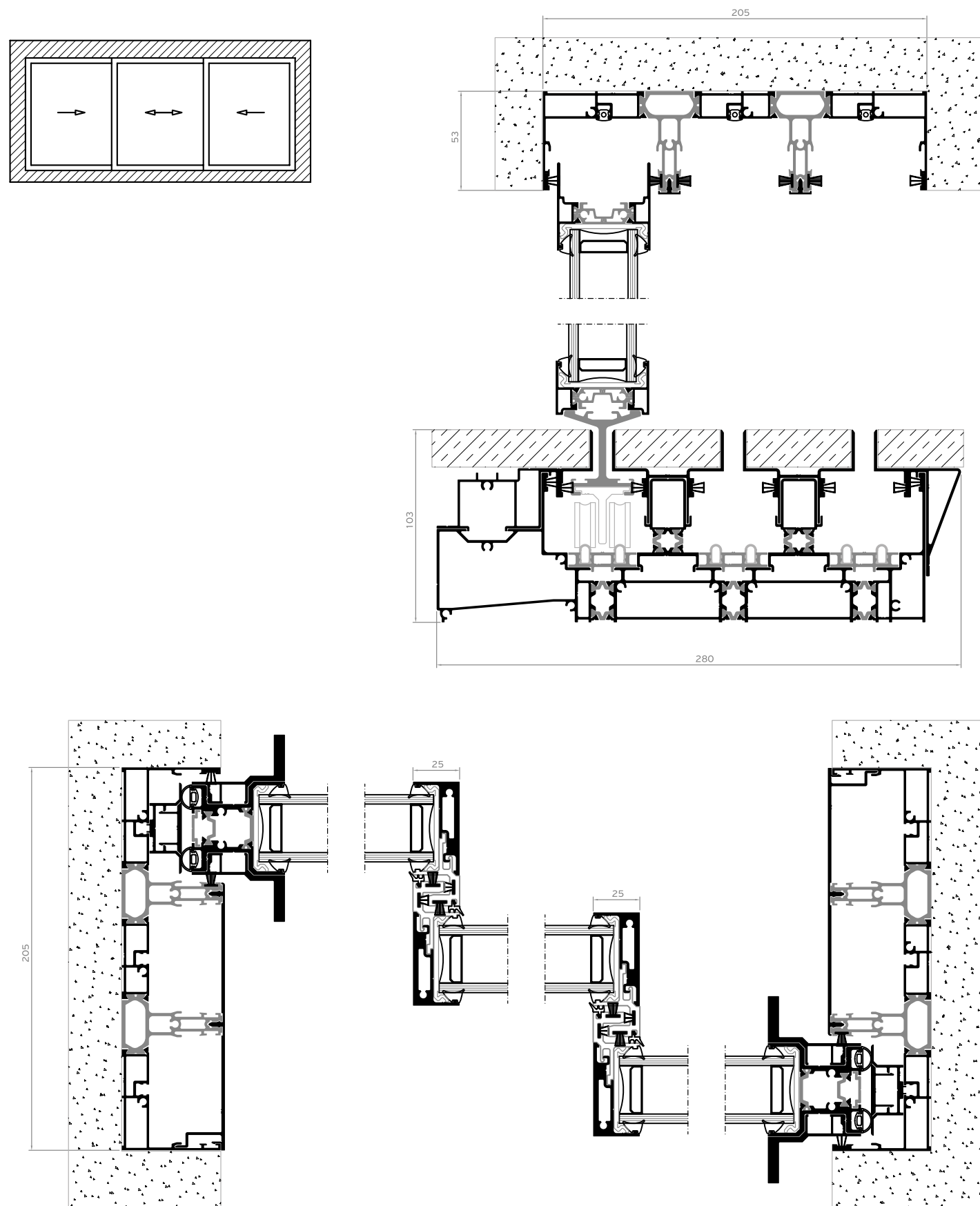

3 Sashes / 3 Track / Total Eclipse

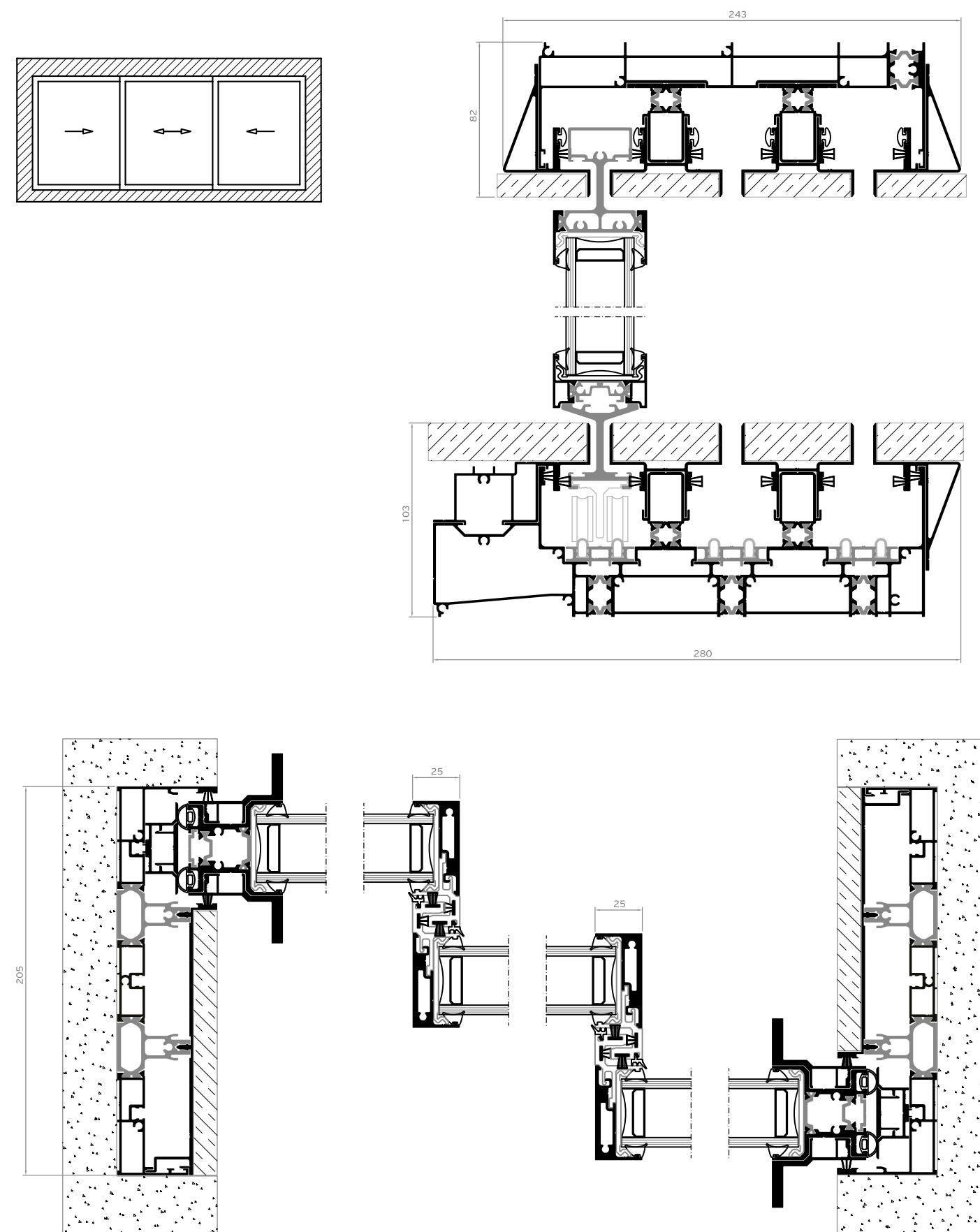

### 2 Sashes / 2 Track Integrated Flyscreen IFS

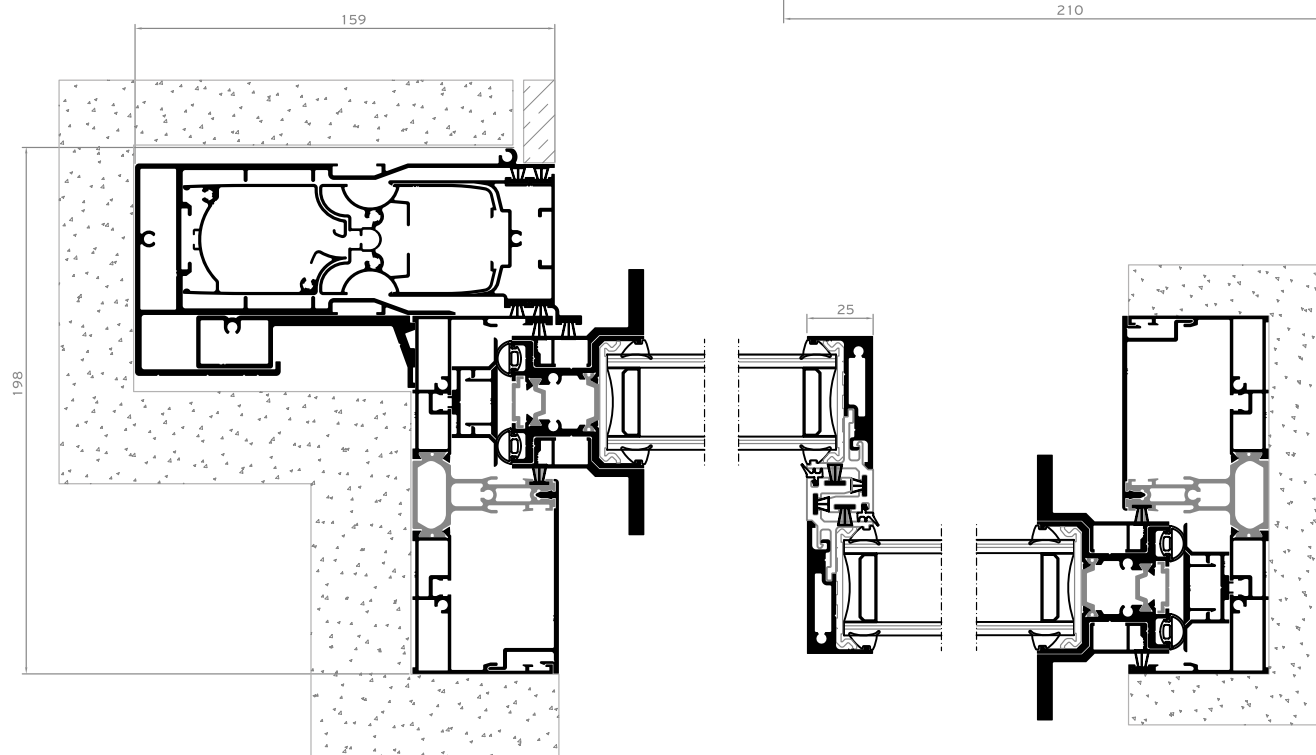
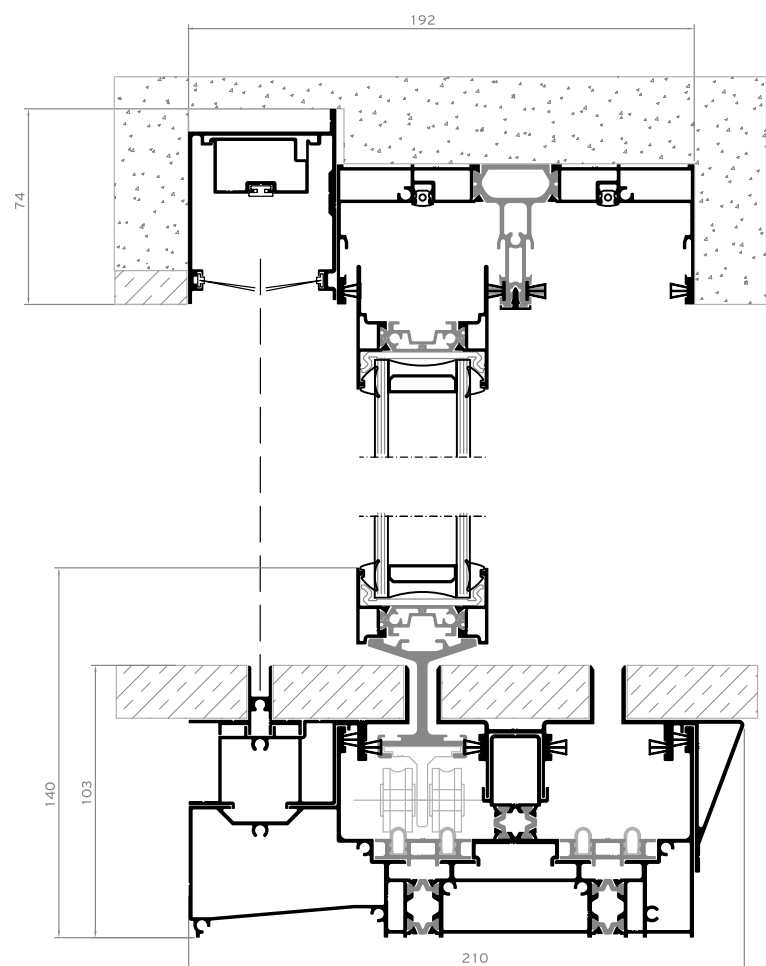
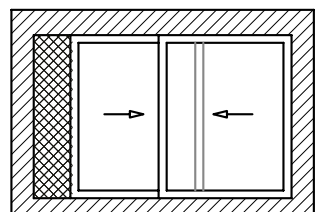

### 2 Sashes / 2 Track / Integrated Flyscreen IFS / Total Eclipse

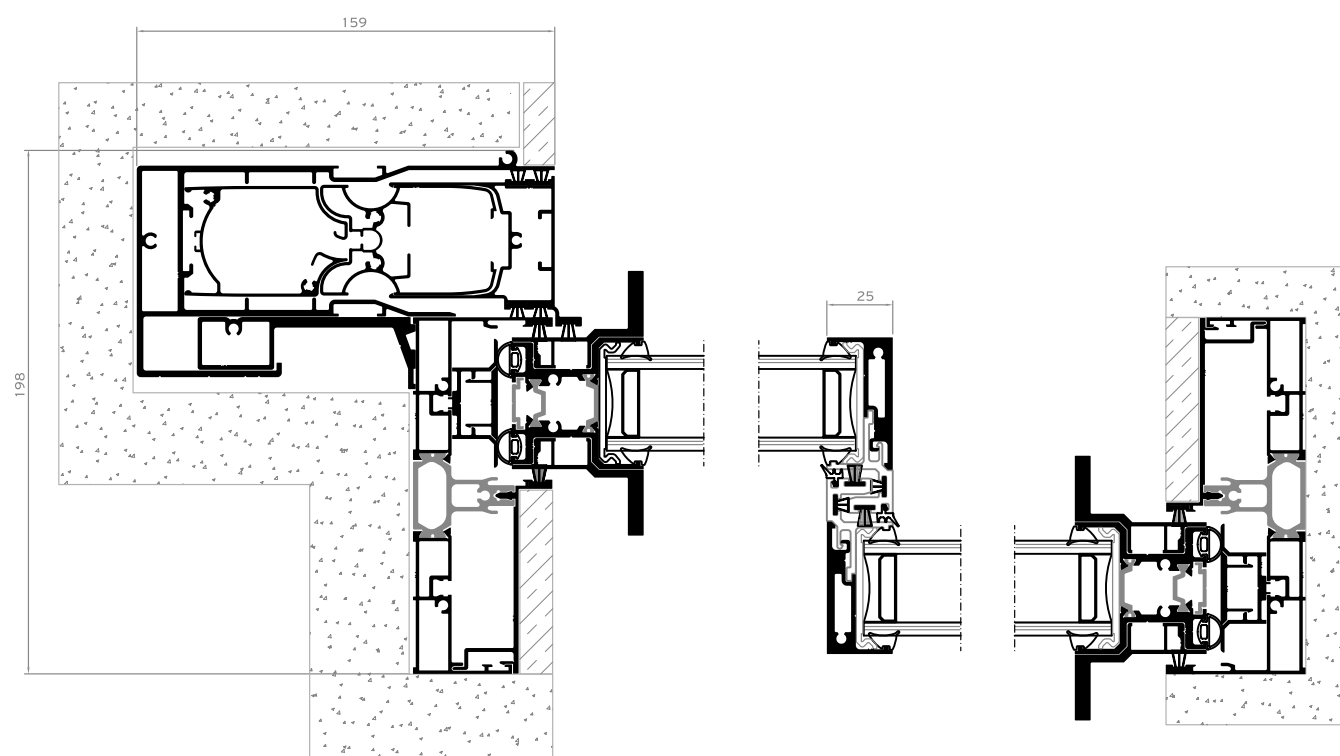
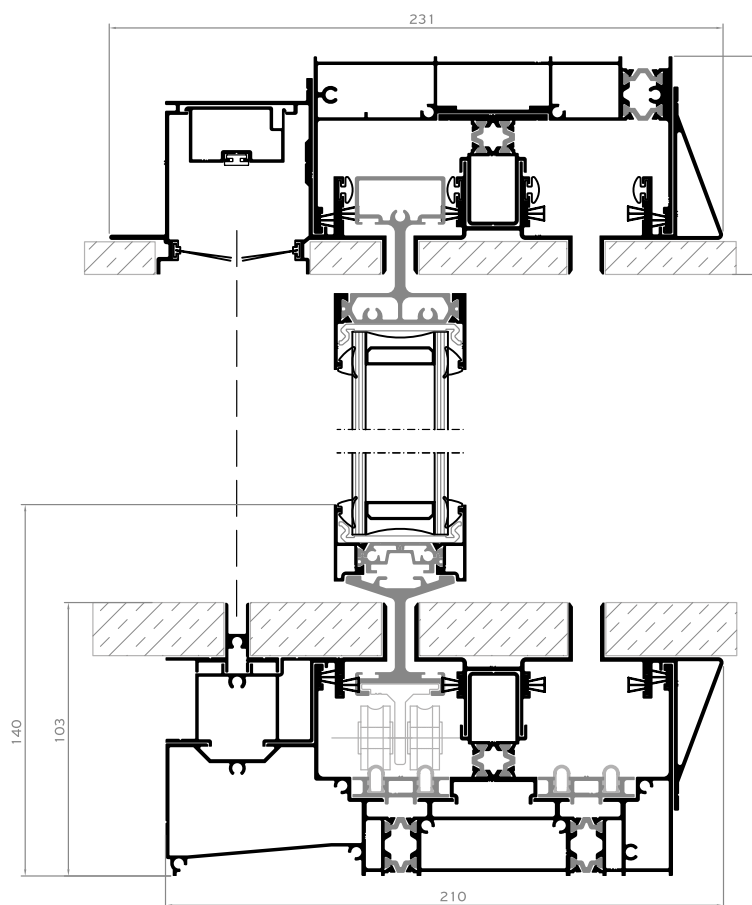
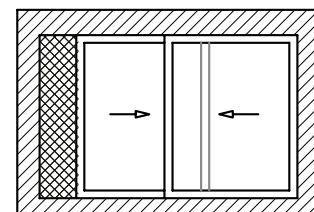

### 1 Sash / 1 Fixed

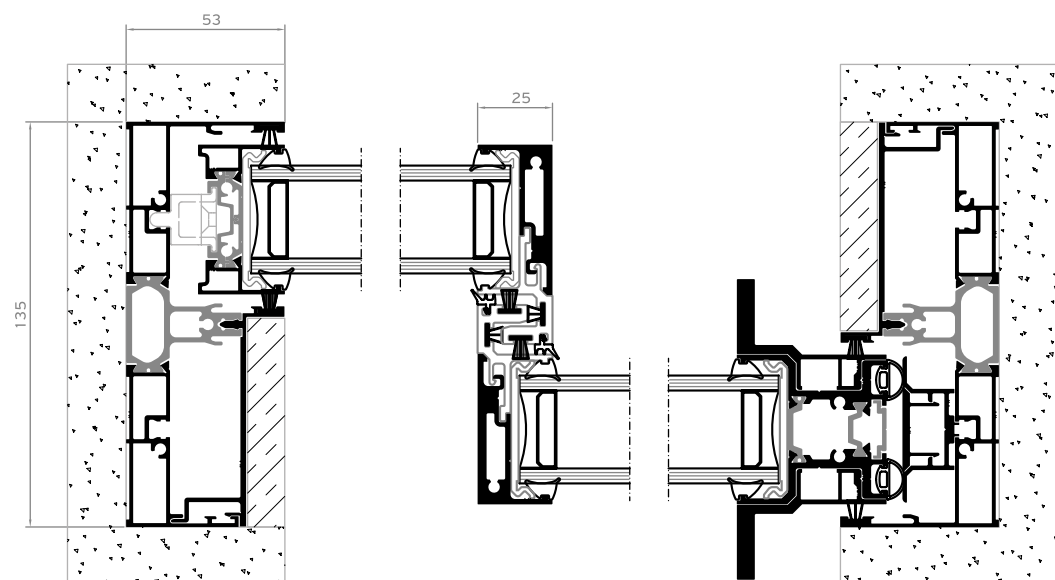
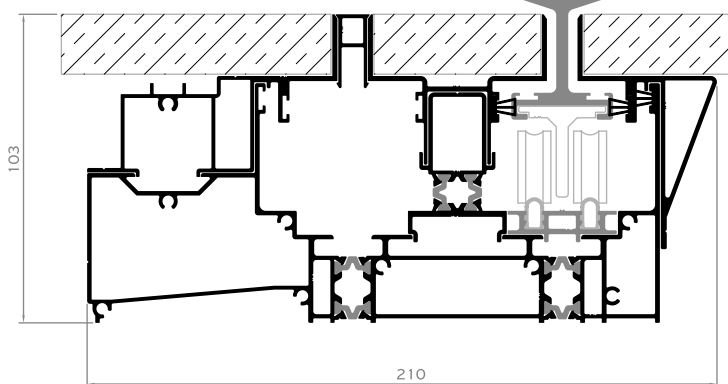
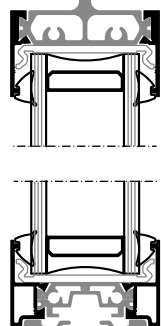
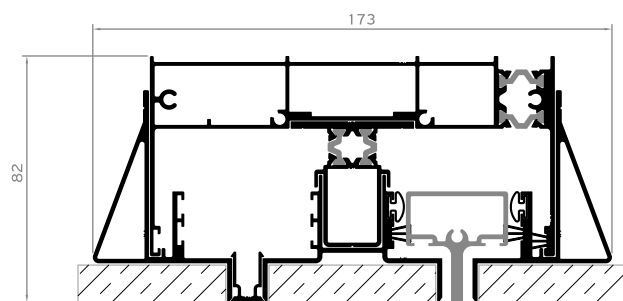
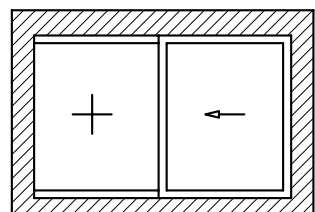

### 4 Sashes / 2 Track

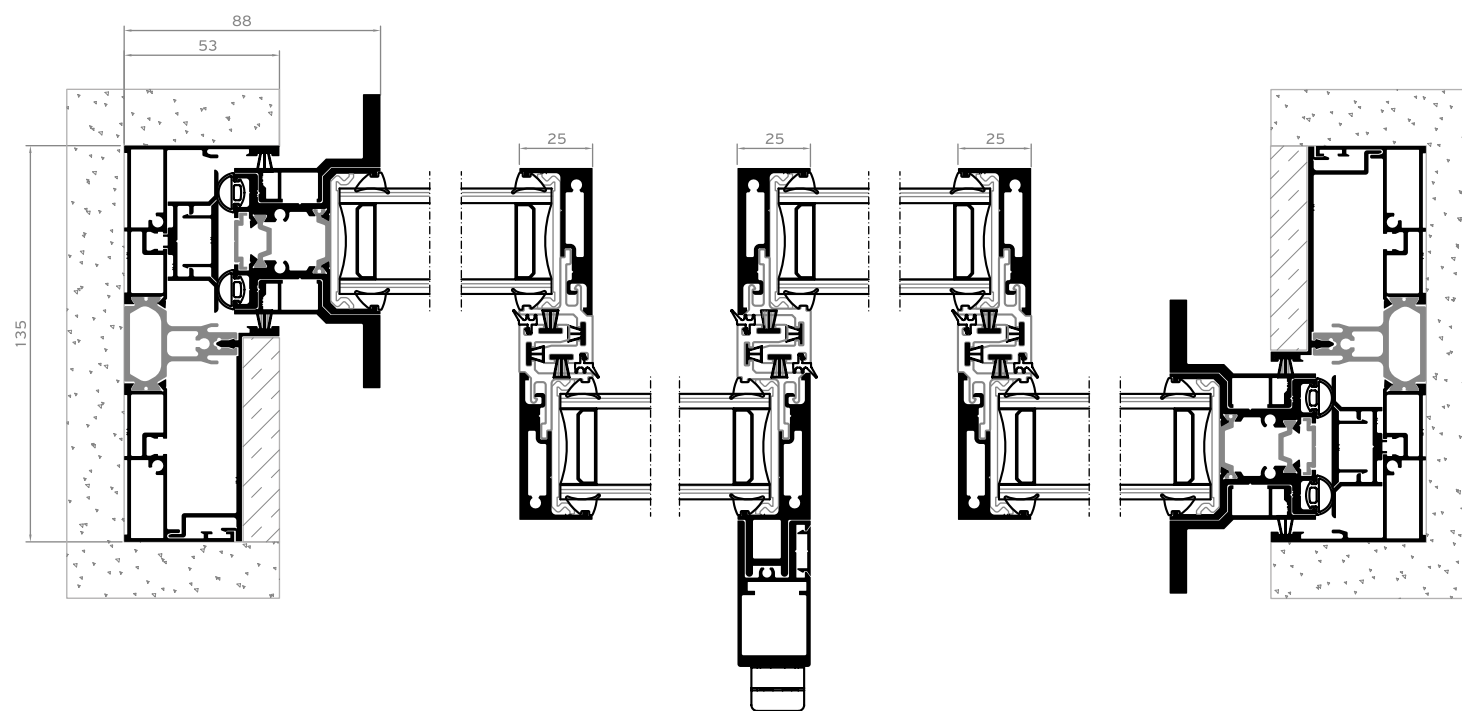
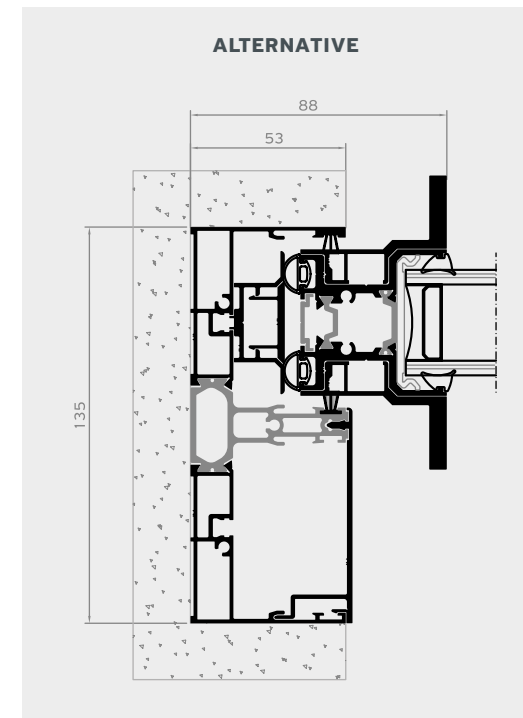
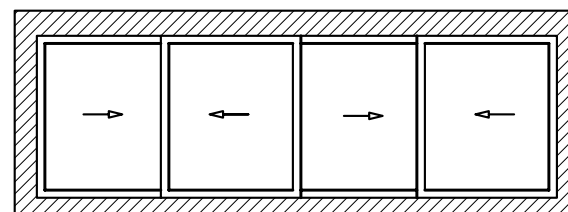

### EXTERNAL CORNER

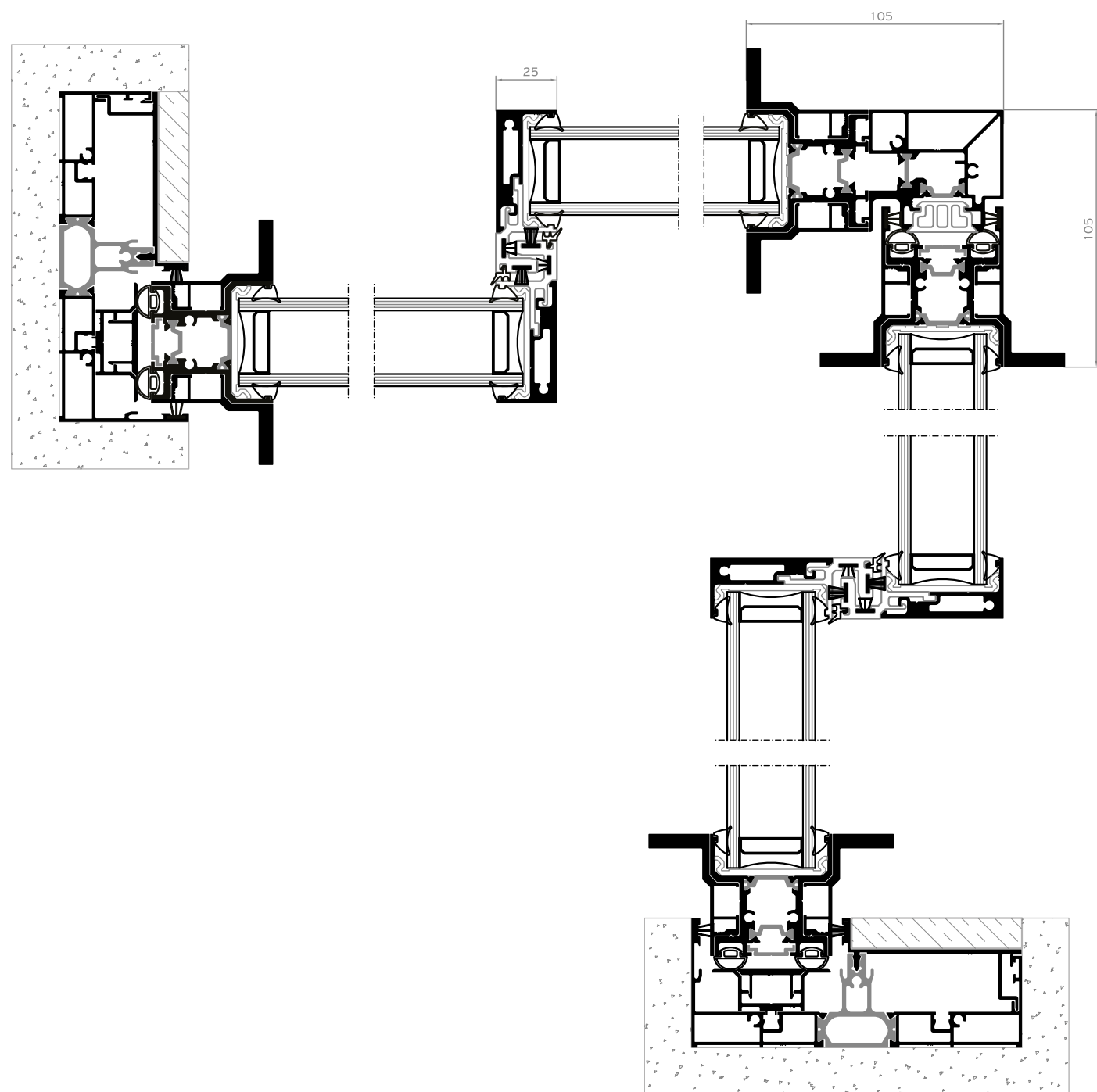
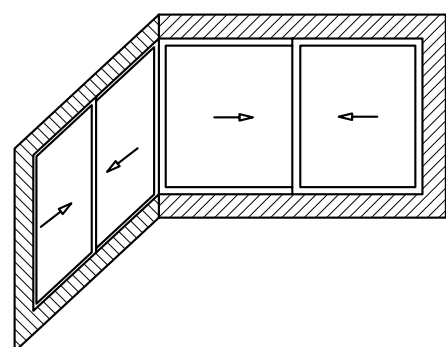

### MULTI TRACK

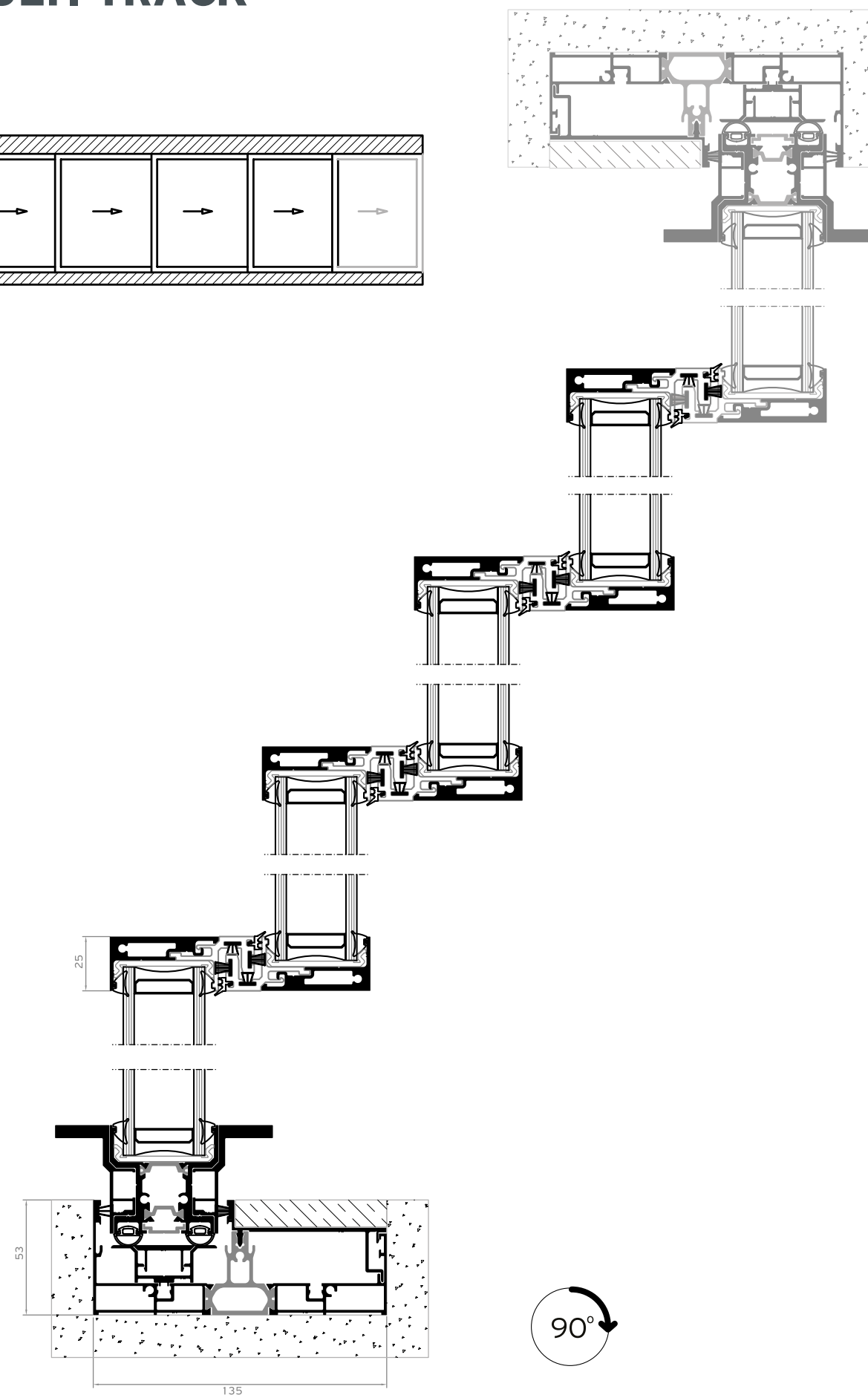
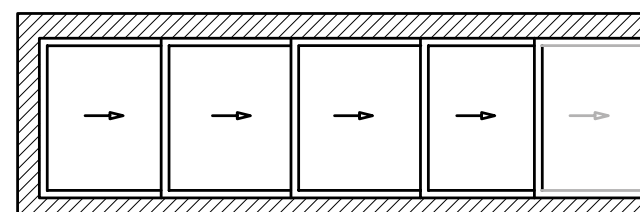







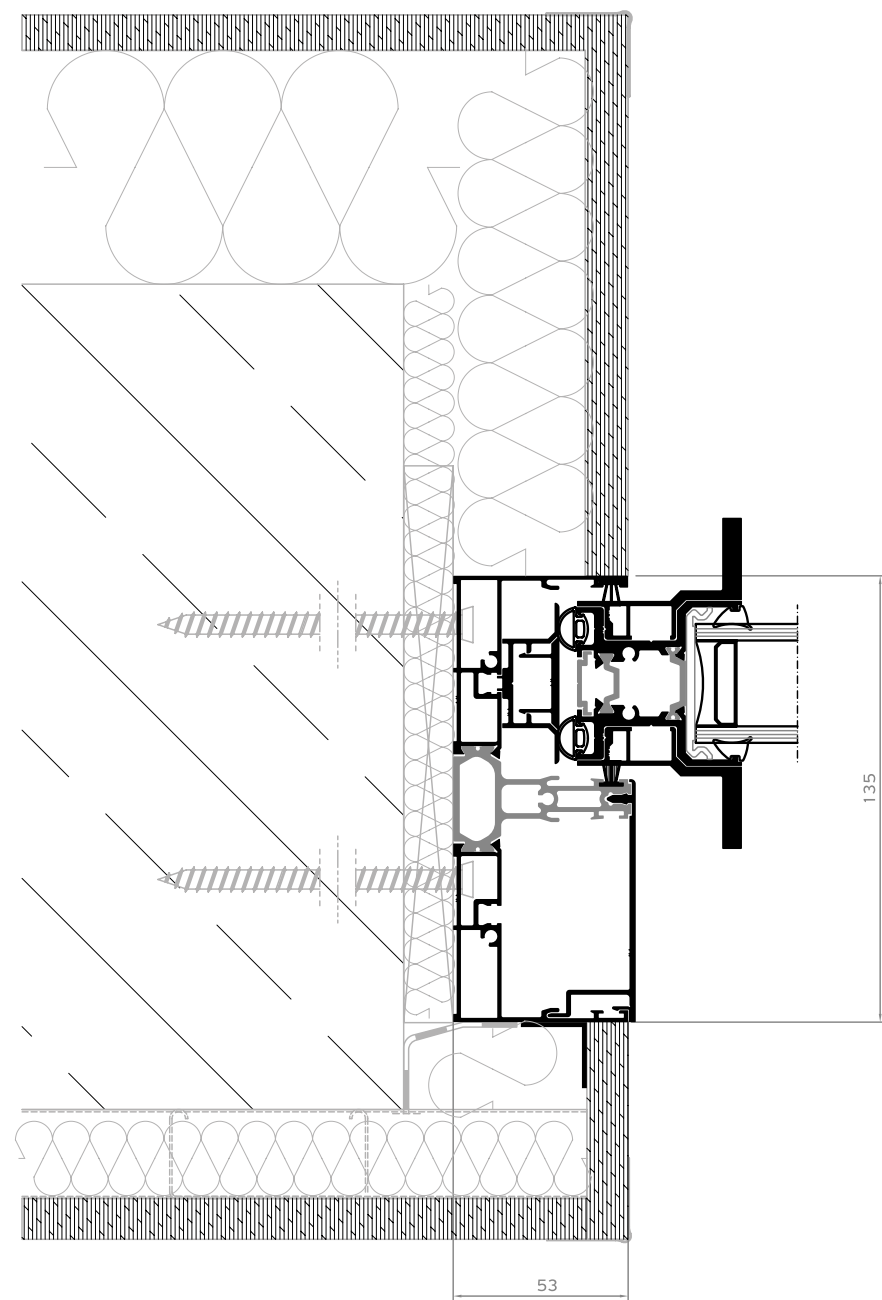





# Installation

SIDE SECTION ECLIPSE



-  PRECOMPRESSED MULTI-FUNCTION SEALING TAPE
-  BACKER ROD
-  HYBRID SEALANT OR NEUTRAL SILICONE
-  STYRODUR HIGH DENSITY BOARD
-  MARBLE
-  POLYURETHANE FOAM
-  POLYSTYRENE
-  WALL CONSTRUCTION
-  WALL FINISH
-  REINFORCED CONCRETE
-  AIR WATER VAPOR BARRIER TAPE

SIDE SECTION TOTAL ECLIPSE

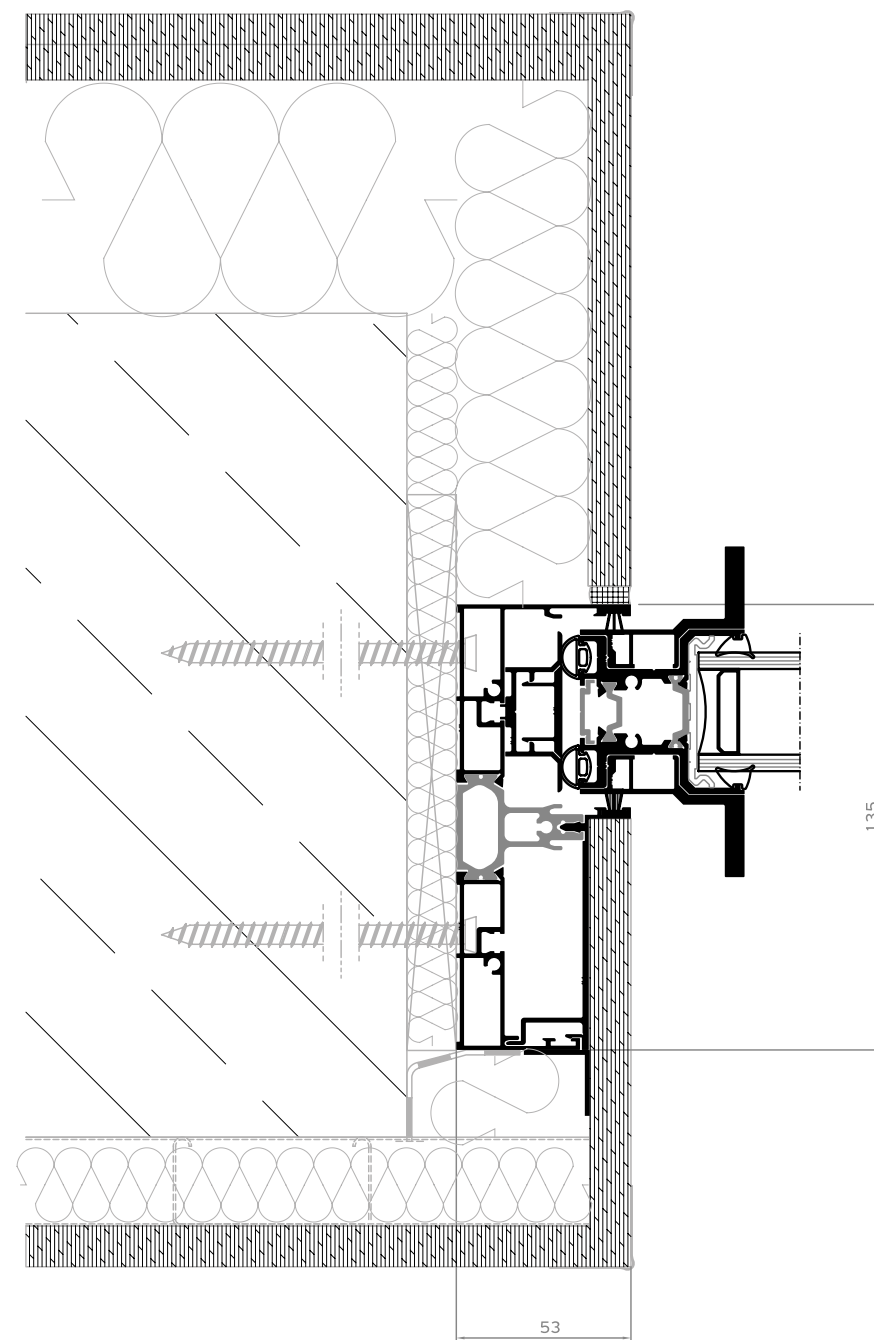

# Installation

TOP SECTION  
ECLIPSE

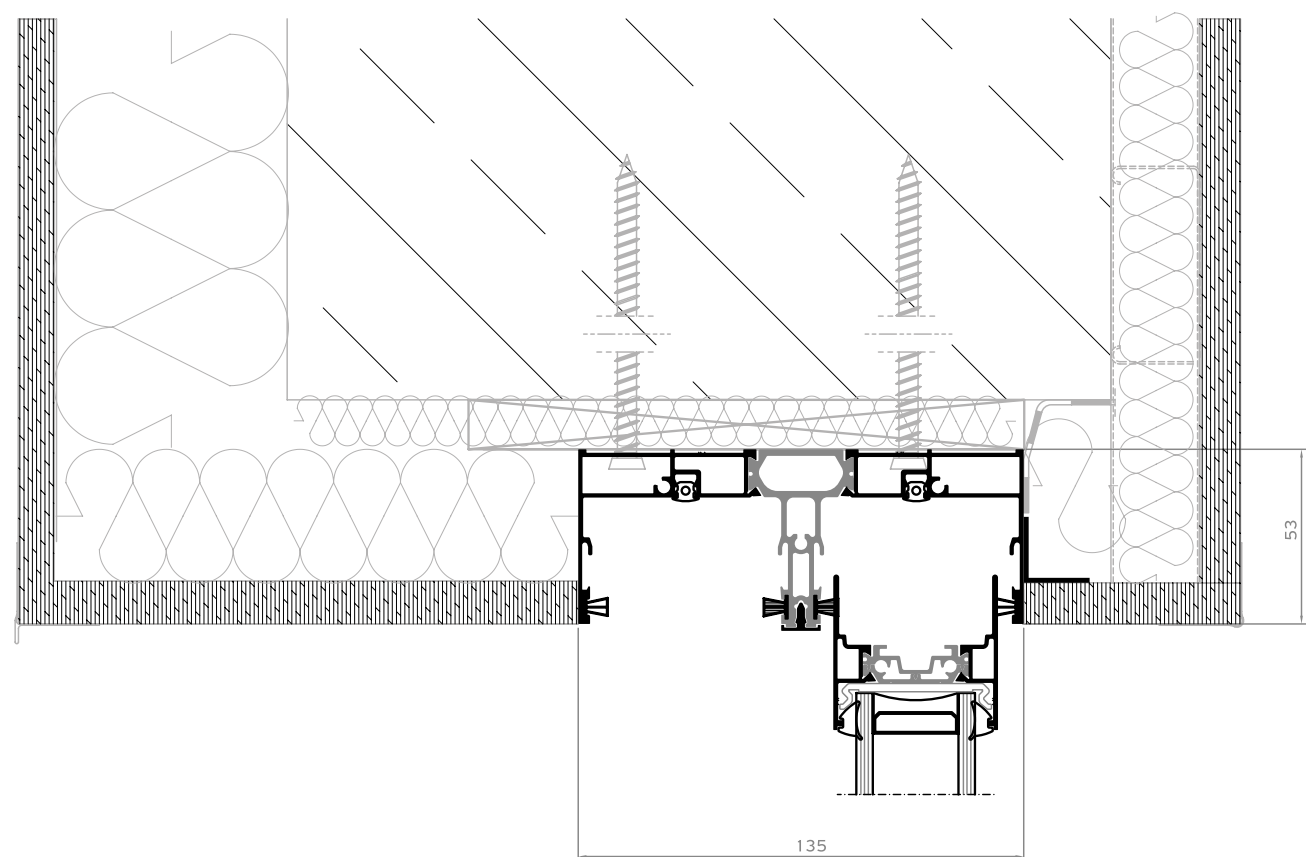

TOP SECTION  
TOTAL ECLIPSE

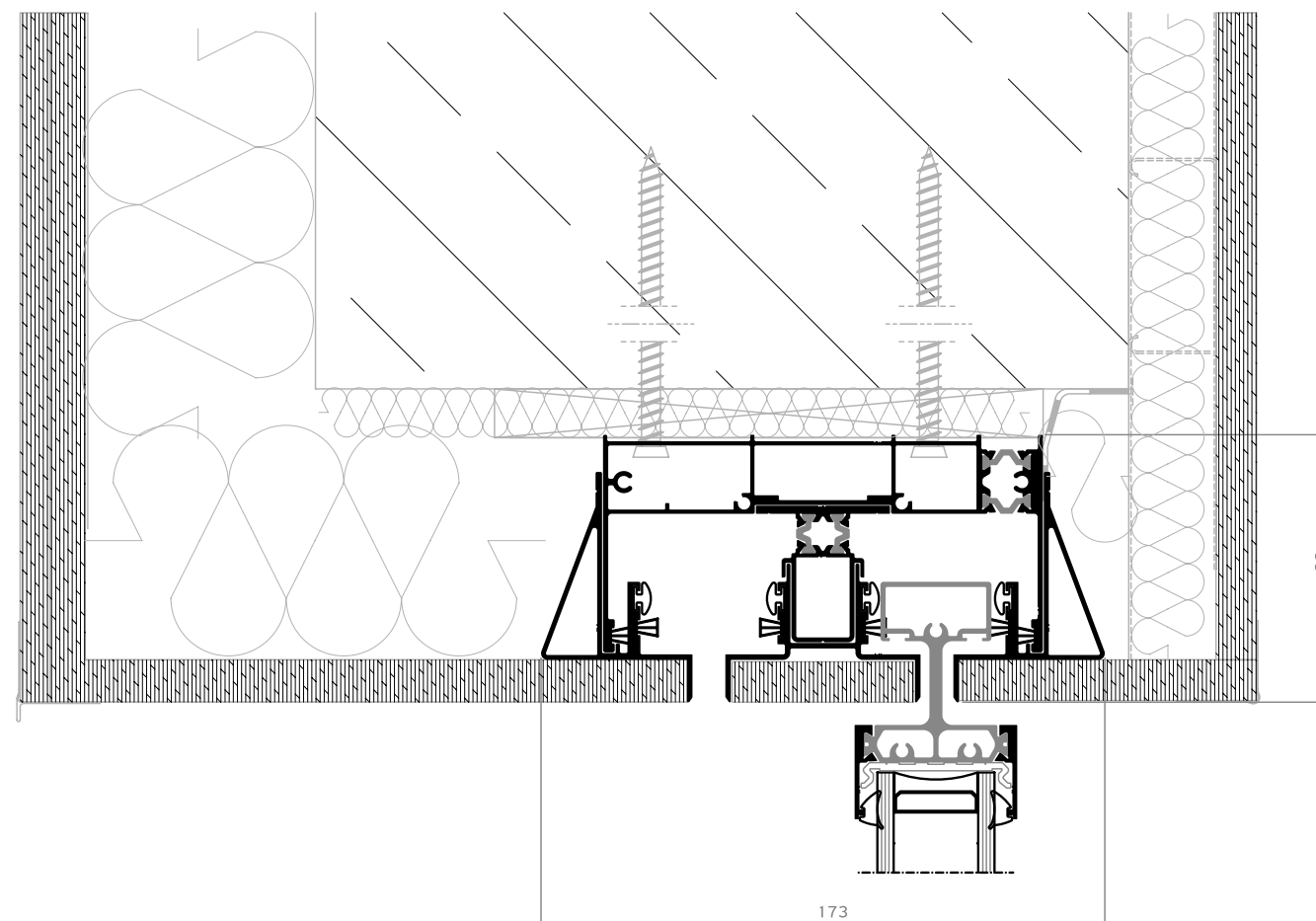

# Installation

BOTTOM SECTION  
VERSION A

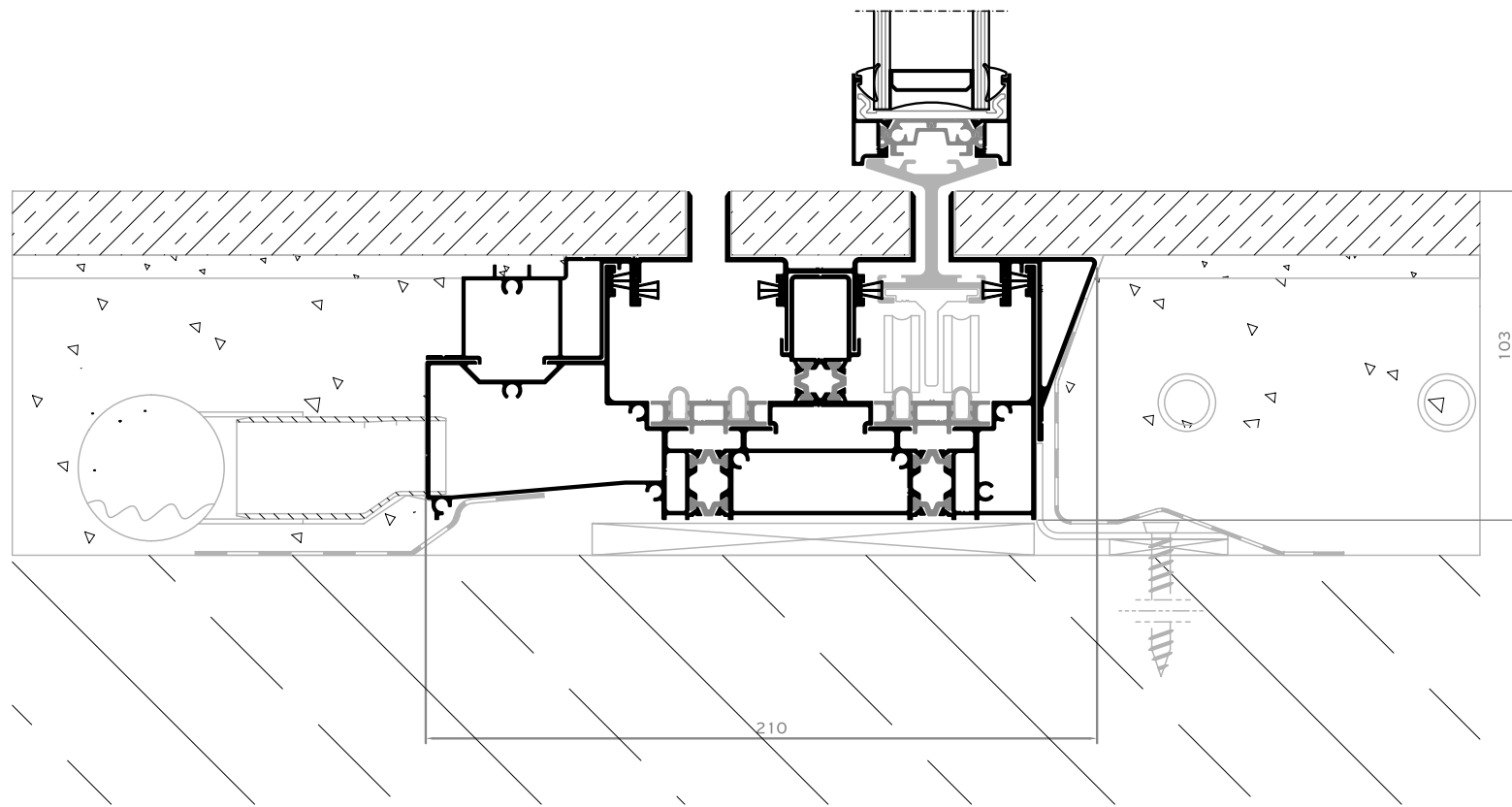

BOTTOM SECTION  
VERSION B

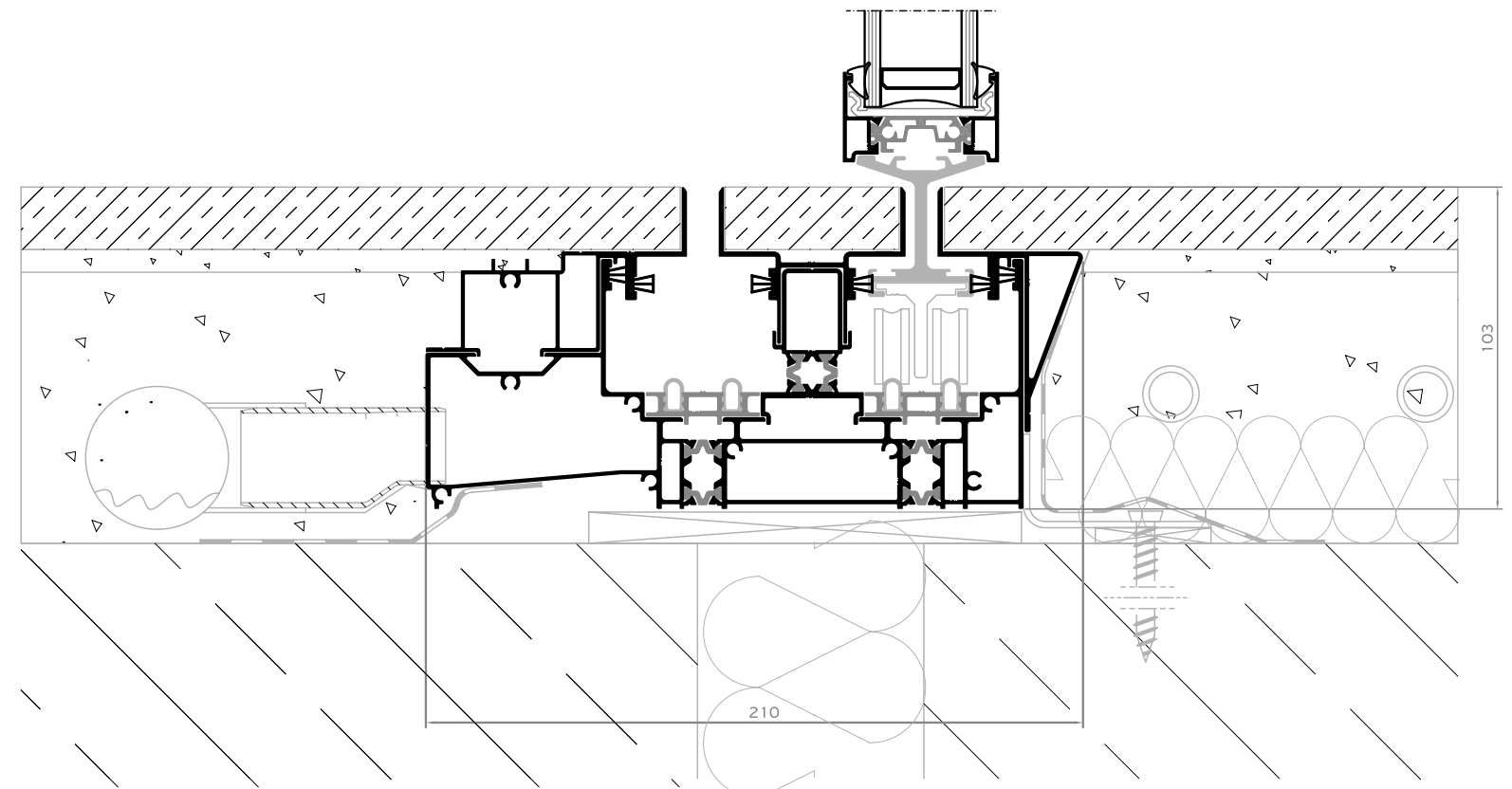

# Installation

SIDE SECTION  
WITH INTEGRATED FLYSCREEN IFS

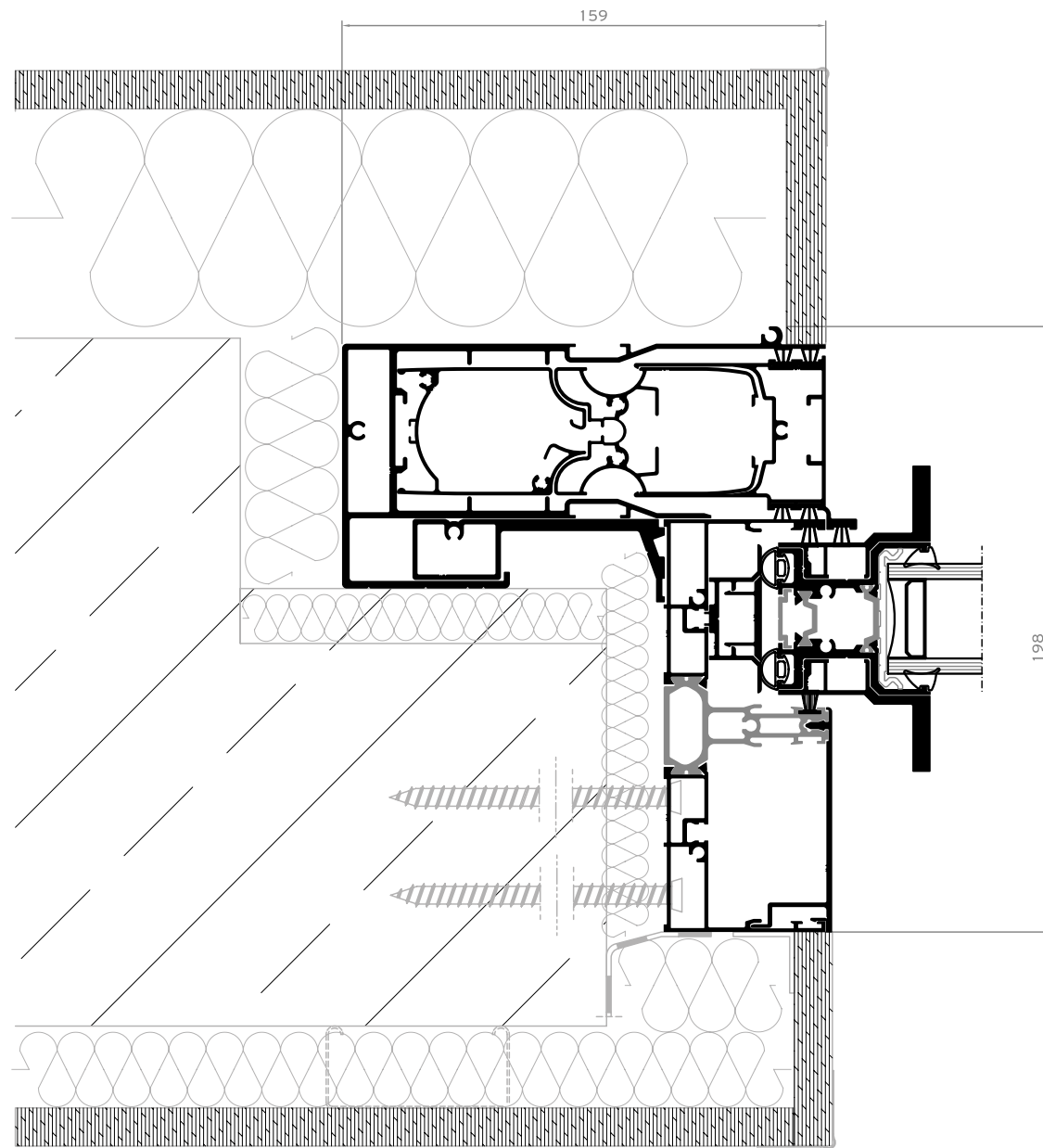

TOP SECTION  
WITH INTEGRATED FLYSCREEN IFS

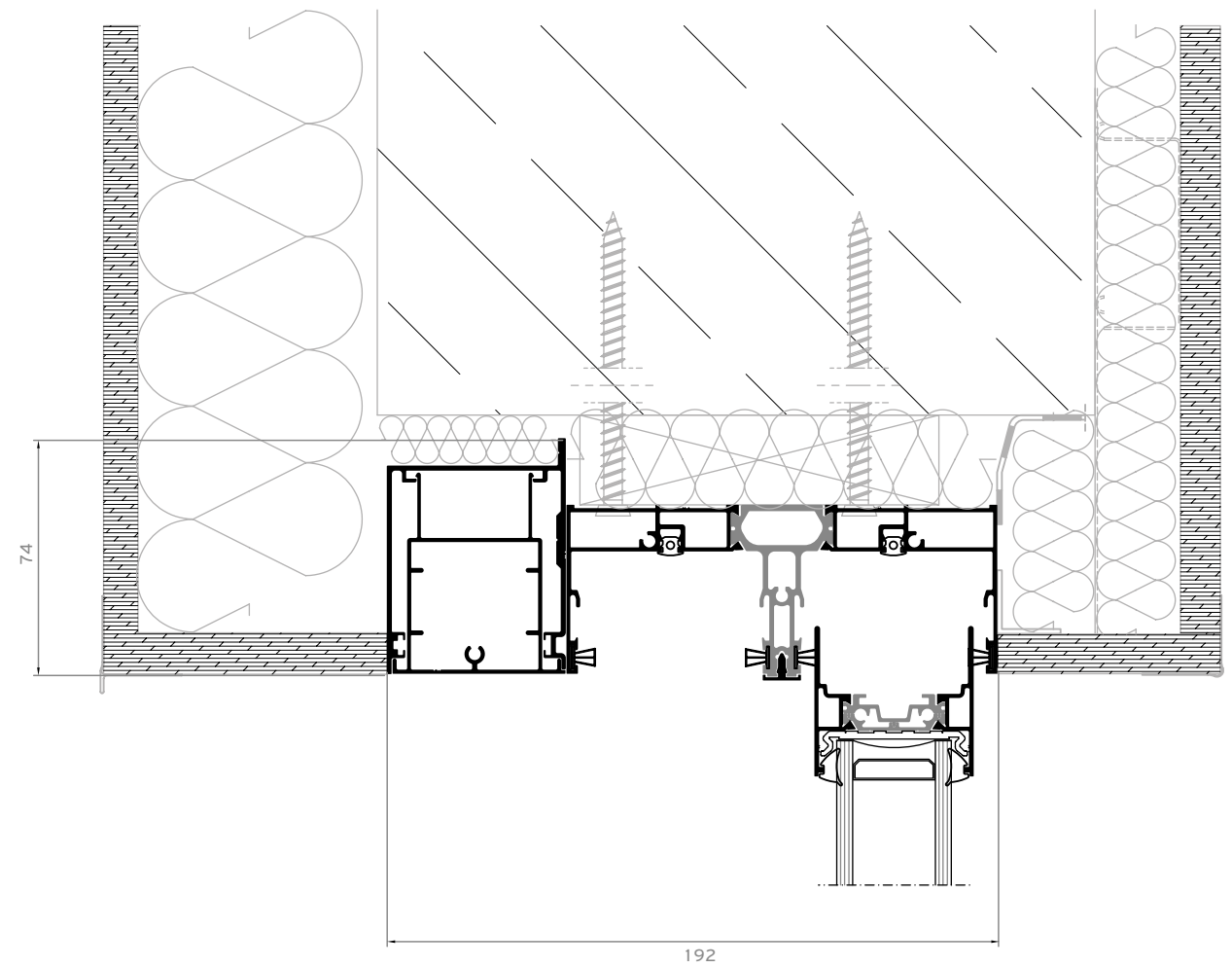

# Applications

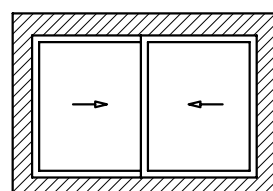

2 SASHES / 2 TRACK

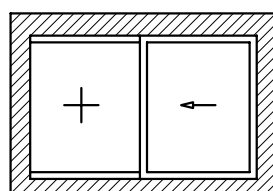

1 SASH / 1 FIXED

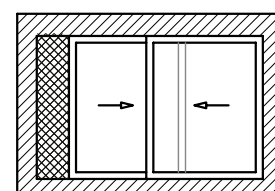

2 SASHES / 2 TRACK  
INTEGRATED FLYSCREEN  
IFS\*

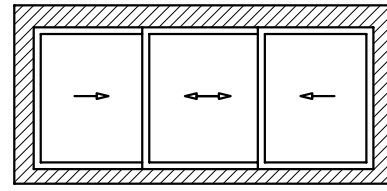

3 SASHES / 3 TRACK

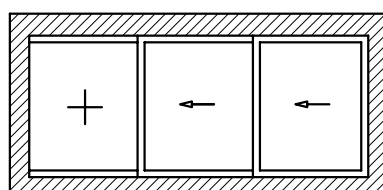

2 SASHES / 1 FIXED

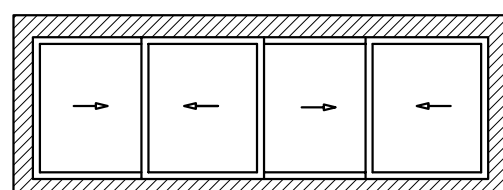

4 SASHES / 2 TRACK

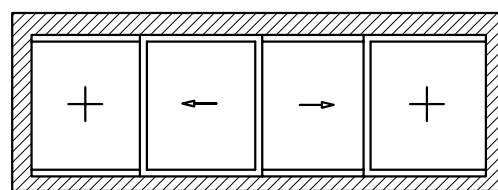

1 FIXED / 2 SASHES / 1 FIXED

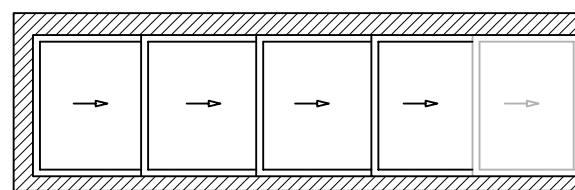

MULTI TRACK

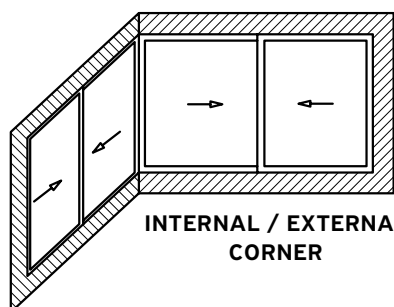

INTERNAL / EXTERNAL  
CORNER

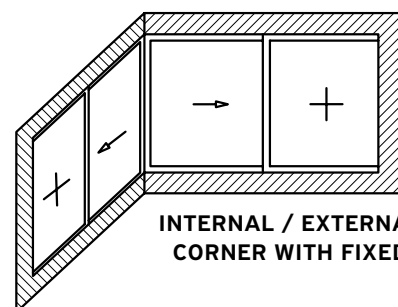

INTERNAL / EXTERNAL  
CORNER WITH FIXED

\* The solution of INTEGRATED FLYSCREEN IFS is available in more typologies of SUPREME S500, provided:  
- it is concealed within the side walls  
- it cooperates with the external sash of the typology

# Table of performance

## CERTIFICATION



**WATER TIGHTNESS**  
EN 12208



**AIR PERMEABILITY**  
EN 12207



**WIND RESISTANCE**  
MAX TEST PRESSURE  
EN 12210



**WIND LOAD RESISTANCE**  
TO FRONTAL DEFLECTION  
EN 12210



**SOUND REDUCTION**  
EN 10140, EN 717

## CLASSIFICATION

1A (0 Pa)	2A (50 Pa)	3A (100 Pa)	4A (150 Pa)	5A (200 Pa)	6A (250 Pa)	<b>7A</b> <b>(300 Pa)</b>	8A (450 Pa)	9A (600 Pa)
1		2		3		<b>4</b>		
1 (400 Pa)	2 (800 Pa)		<b>3</b> <b>(1200 Pa)</b>	4 (1600 Pa)	5 (2000 Pa)			
A (≤ 1/150)			B (≤ 1/200)			<b>C</b> <b>(≤ 1/300)</b>		
41 dB								

## THERMAL PERFORMANCE

2 SASHES / 2 TRACK

2 SASHES / 2 TRACK

DIMENSIONS IN MM  
(W x H)

2600 x 2400

4000 x 3000

U<sub>w</sub> in W/m<sup>2</sup>K  
(U<sub>g</sub> = 0,8)

1,39

1,23

U<sub>w</sub> in W/m<sup>2</sup>K  
(U<sub>g</sub> = 1,0)

1,55

1,40

U<sub>w</sub> in W/m<sup>2</sup>K  
(U<sub>g</sub> = 1,1)

1,64

1,49

www.alumil.com

DISCOVER MORE:



WATCH THE VIDEO:



**ALUMIL  
HEAD OFFICES  
& SHOWROOM - THESSALONIKI**

GOGOUSI 8, EFKARPIA  
THESSALONIKI - GR 56429  
TEL.: +30 2313011000  
FAX.: +30 231692473  
E-MAIL.: info@alumil.com

**ALUMIL  
HEADQUARTERS**

KILKIS INDUSTRIAL AREA  
KILKIS - GR 61100  
TEL.: +30 23410 79300  
E-MAIL.: info@alumil.com



**ALUMIL  
HEAD OFFICES  
& SHOWROOM - THESSALONIKI**

GOGOUSI 8, EFKARPIA  
THESSALONIKI - GR 56429  
TEL.: +30 2313011000  
FAX.: +30 231692473  
E-MAIL.: info@alumil.com

**ALUMIL  
HEADQUARTERS**

KILKIS INDUSTRIAL AREA  
KILKIS - GR 61100  
TEL.: +30 23410 79300  
E-MAIL.: info@alumil.com

[www.alumil.com](http://www.alumil.com)

EN NOV 2024

The logo for ALUMIL, featuring the word 'alumil' in a lowercase, sans-serif font. The letter 'l' is stylized with a yellow vertical bar on its right side. The logo is positioned in the bottom left corner of the page, overlaid on a dark wooden deck and a swimming pool.

**alumil**