



**Alumil**  
Building excellence every day

**Alumil**  **SMARTIA**  
**M630 PHOS**



# CONTENTS

## **SMARTIA M630 PHOS**

DESIGN PHILOSOPHY & CHARACTERISTICS	4
SENSE OF FREEDOM	8
ATTENTION TO DETAIL	10
EXPLOITING EVERY CONTEMPORARY NEED	14
SECTIONS	18
INSTALLATION	30
APPLICATIONS	34
PERFORMANCE	35



## **SMARTIA M630 PHOS**

is the ideal choice for minimal thermally insulated sliding windows and doors with wide glazing surfaces. The system can be installed either on-floor or flush to the floor offering a unique combination of elegance and functionality, satisfying even the most demanding requirements.

### **PHOS** means **LIGHT**

*"I sense Light as the giver of all presences, and material as spent Light.  
What is made by Light casts a shadow, and the shadow belongs to Light."*

Not just a window  
a point of view.

The sliding system  
SMARTIA M630 PHOS  
offers a minimal touch...

in contemporary residences combining  
minimal design with **high thermal  
performance.**



Following the  
“**less is more**” philosophy,  
all aluminium profiles can  
be hidden into the walls  
providing a total sense of  
comfort with top functionality  
and enhanced safety.

- Design ideal for “green” buildings, emphasizing on energy & money savings through thermally efficient solutions.
- Maximum natural light with only 44 mm of visible aluminium face width at the interlocking profile.
- Smart locking mechanism (international patent) with multiple locking points.
- Easy access thanks to the low threshold ideal for children, elders and people with special needs.
- Smooth sliding & maximum functionality with high resistance to corrosion with stainless steel rollers.
- Vast range of typologies available.

**Alumil** SMARTIA  
M630 PHOS

## TECHNICAL

## CHARACTERISTICS

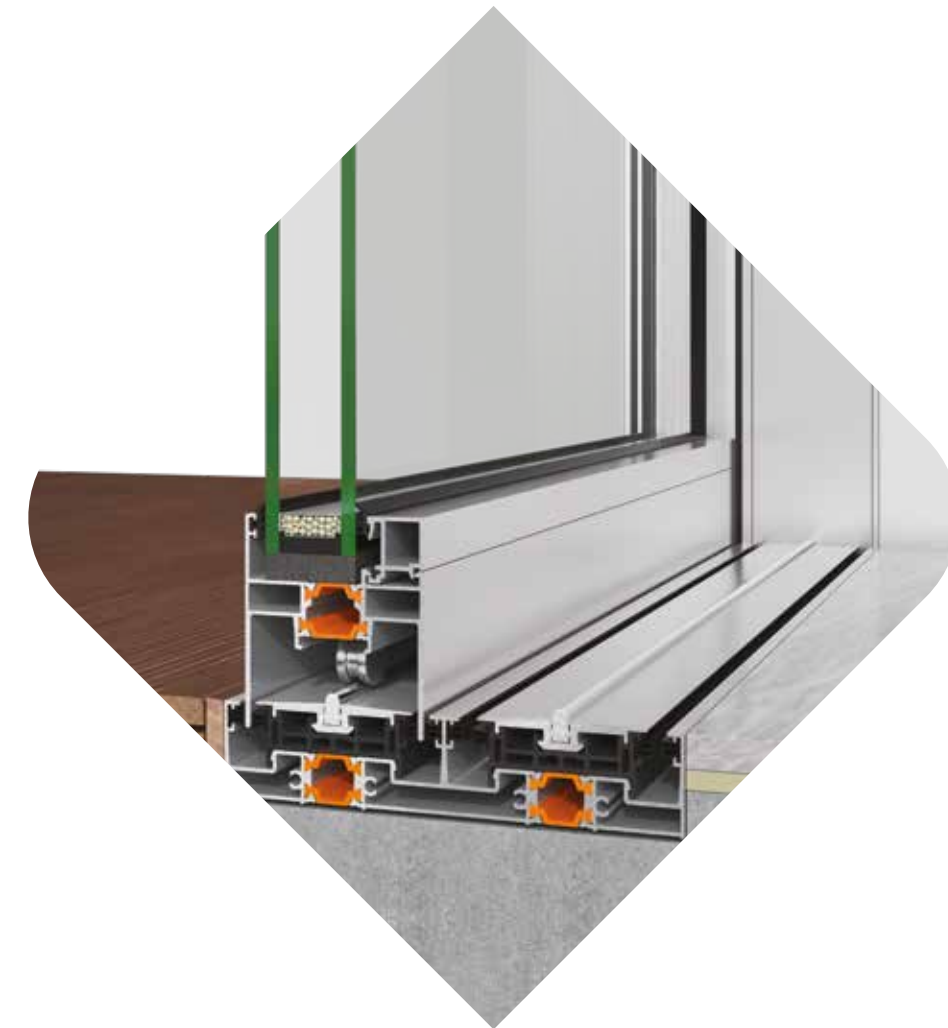

VISIBLE ALUMINIUM FACE WIDTH	CONCEALED PROFILES
FRAME HEIGHT	32 mm
FRAME WIDTH	155 mm
SASH WIDTH	63 mm
INTERLOCKING PROFILE WIDTH	44 mm
SASH WEIGHT	UP TO 250 kg
GLAZING	32 mm
INSULATION	POLYAMIDES, PVC

The system's main characteristic is the aluminium frames that are **totally flush to the wall.**

Thus, it offers to the users **the sense of freedom** and direct interaction with the external environment.

Elegant coziness full of natural light thanks to the **system's minimal design and the wide glazing surfaces that can be integrated.** The visibility is enhanced with the slim interlocking profile of only

**44 mm** visible aluminium face width.

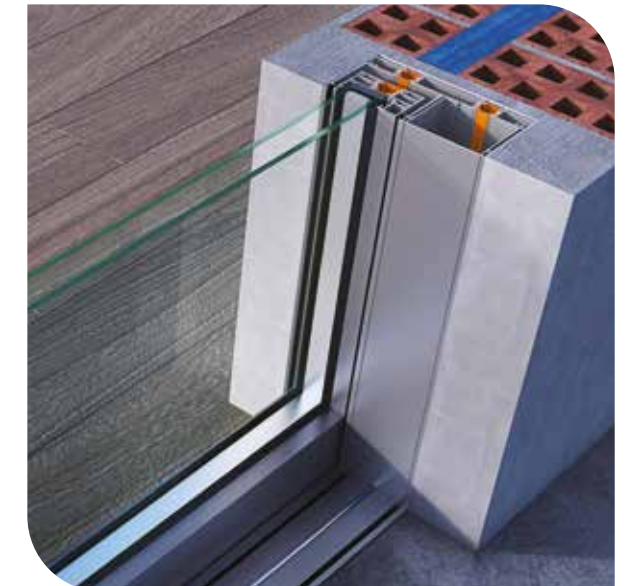

**Alumil** SMARTIA  
M630 PHOS

## ATTENTION

## TO DETAIL

Flat threshold with a **height of only 32mm**, which was specially designed for easy and safe access to children, the elderly and people with special needs.

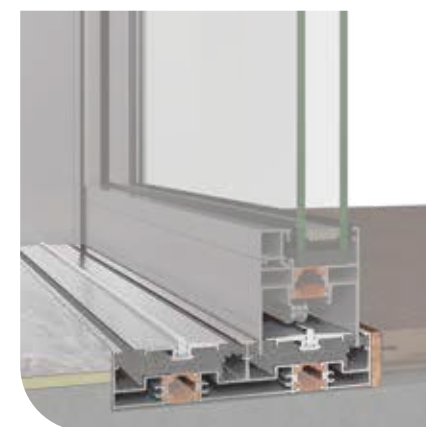

Stainless steel rollers ideal for seaside projects offering **high functionality & smooth gliding** of the sashes.

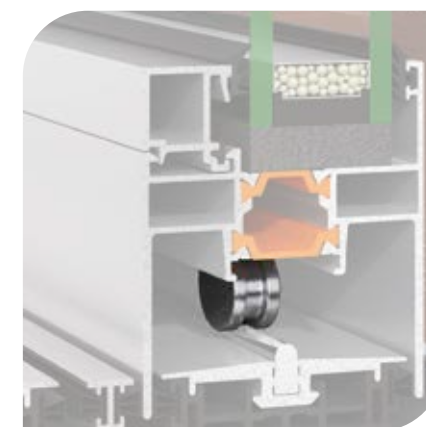

The door sash **glides easily and quietly** on the solid rail made by stainless steel AISI 316L.

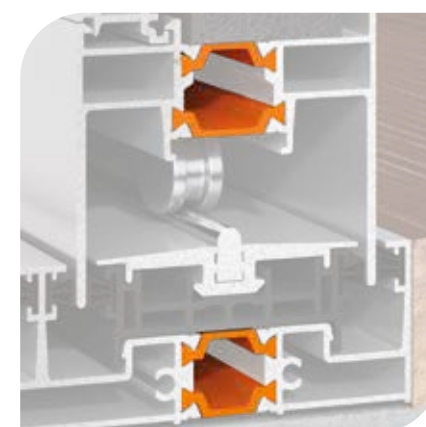

SMARTIA M630 PHOS uses **fiberglass reinforced polyamides** with 24mm & 20mm width, along with the contribute to the system's high energy efficiency.

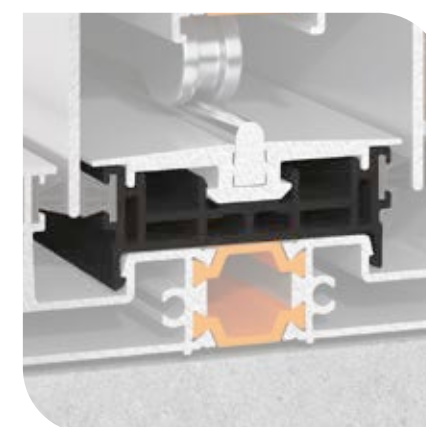

The unique PVC profiles contribute to the system's **the thermal insulation and watertightness**.

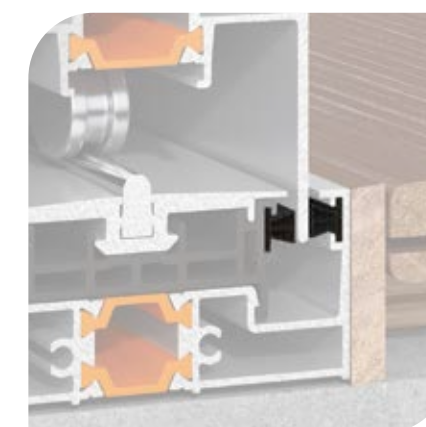

SMARTIA M630 PHOS uses **high quality brushes with triple membrane** contributing significantly to the system's air permeability and watertightness.

Smart locking system  
(international patented)  
with **ALUMIL design handle...**

offer **high security with multiple locking points.**

In addition, they are very easy to install after transportation on site and can be easily removed for maintenance.





The innovative design of the concealed water drainage system offers excellent performance even under adverse weather conditions. Specially perforated profiles and accessories, assembled together, facilitate the water outflow.

Even when the low threshold is selected for top-mounted installation, there is a special component for the concealed water drainage that offers high watertightness.

LOW THRESHOLD

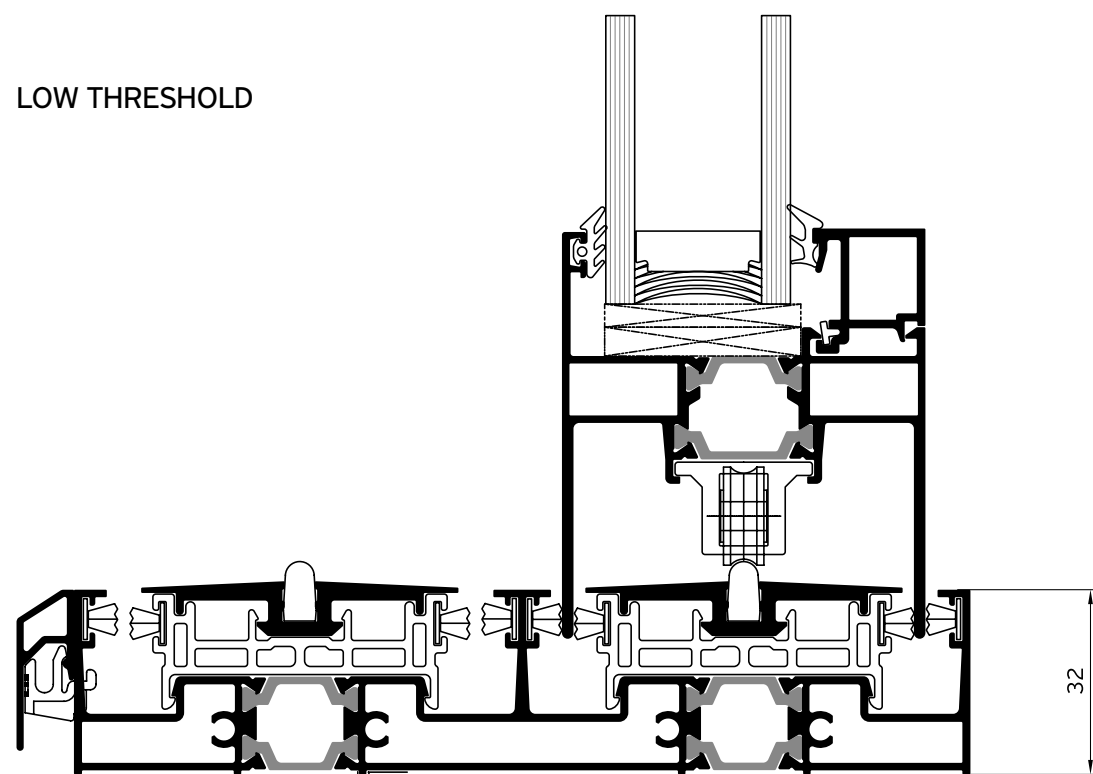

EXPLOITING

EVERY CONTEMPORARY NEED

THRESHOLD WITH SUBSILL

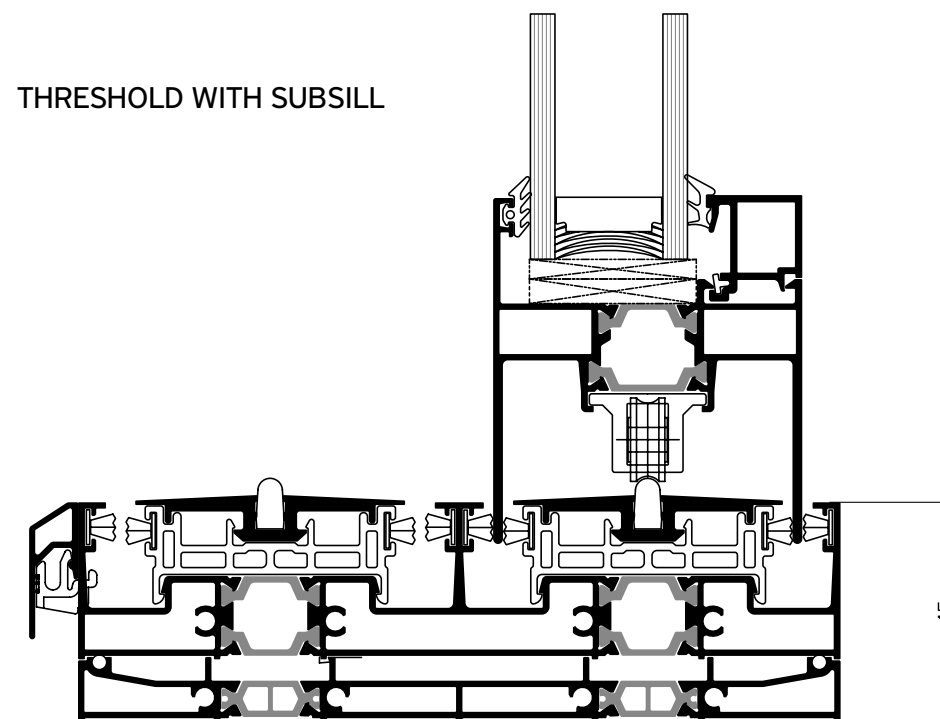

THRESHOLD WITH SUBSILL & GUTTER

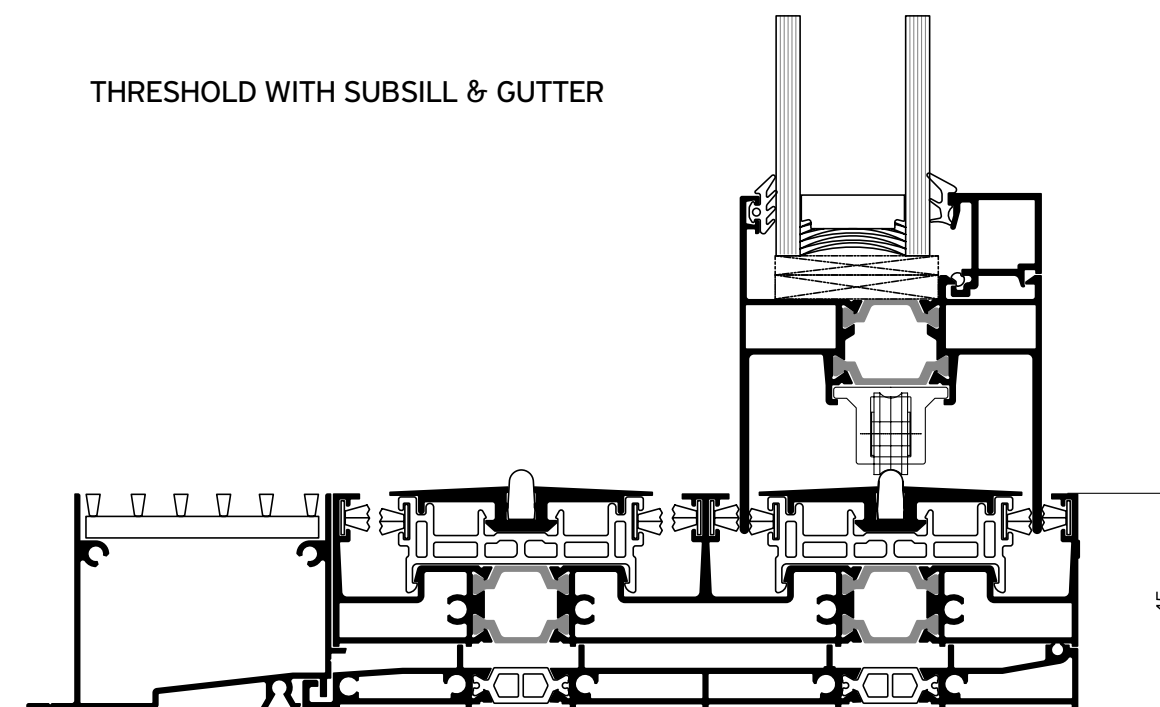

THRESHOLD WITH SUBSILL

**Alumil** SMARTIA  
M630 PH0S

In addition, the reinforced interlocking profile apart from aesthetics and functionality, offers robustness to the structure and resistance to wind loads for higher sashes.

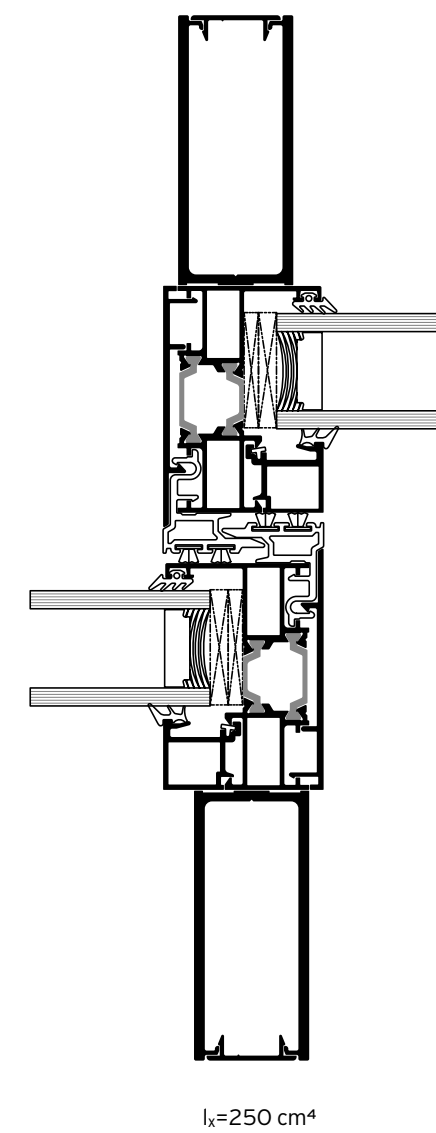
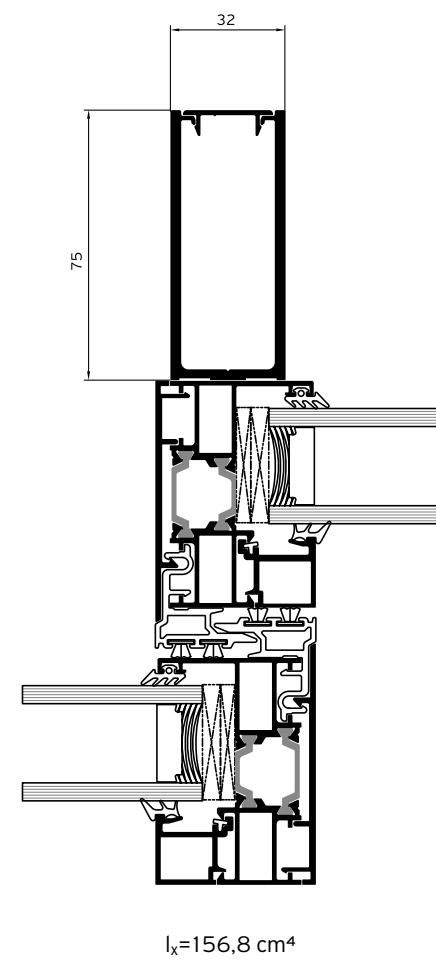
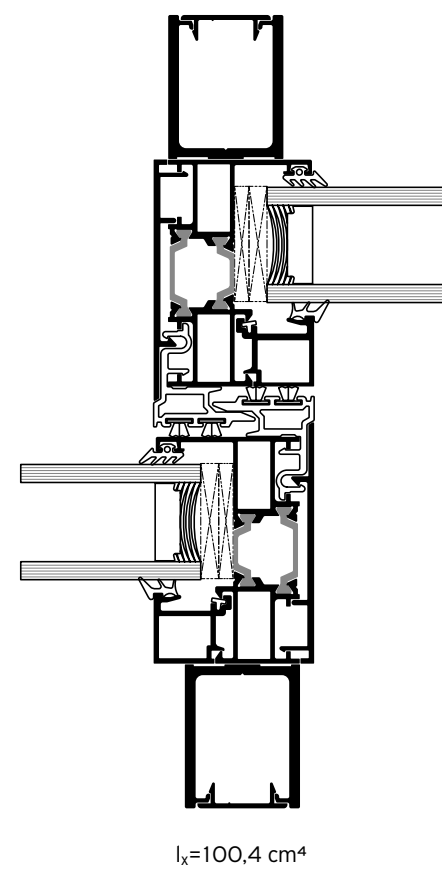
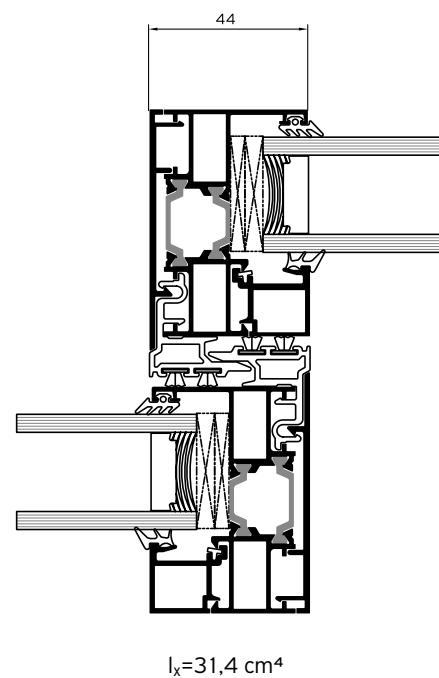
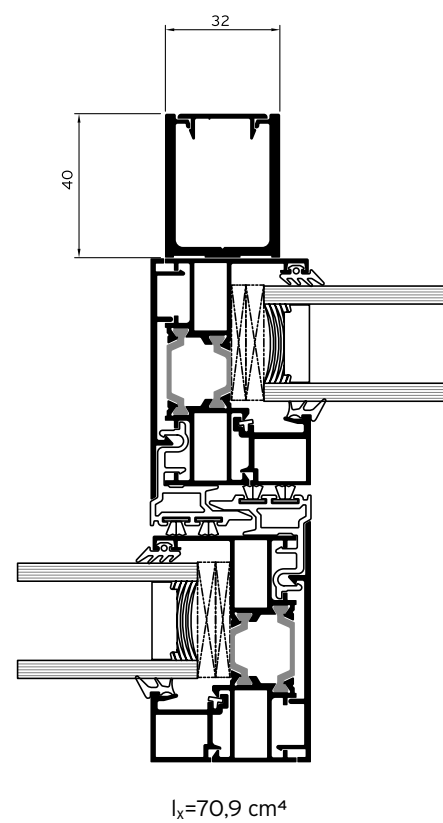

### 2 Sashes / 2 Track

### 1 Sash / Fixed light

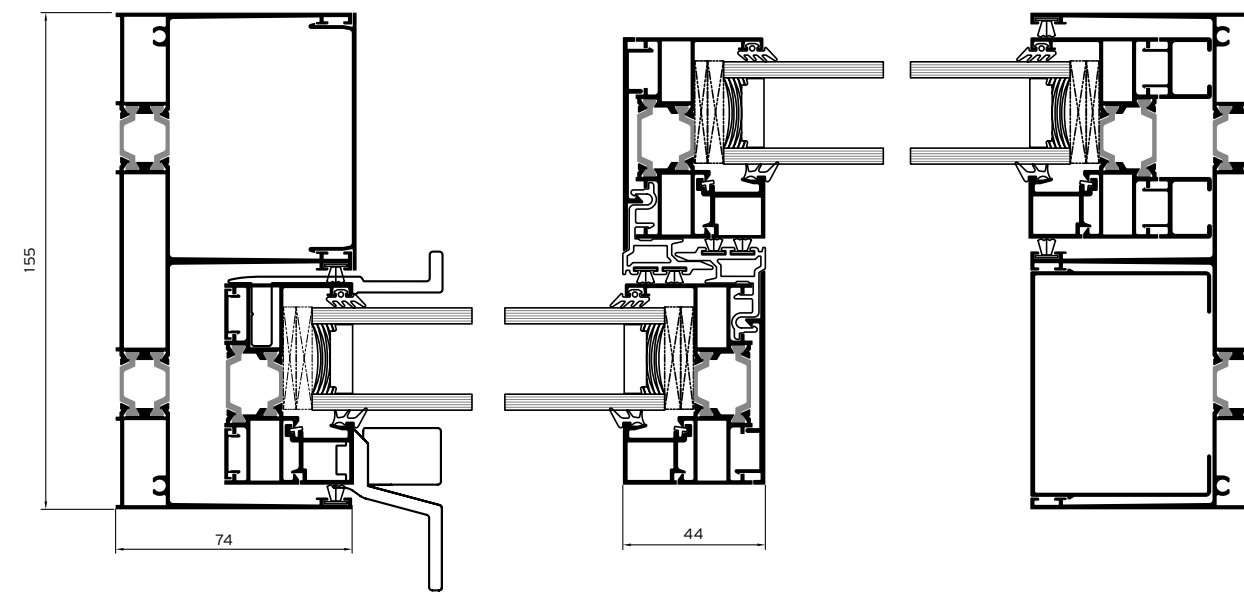
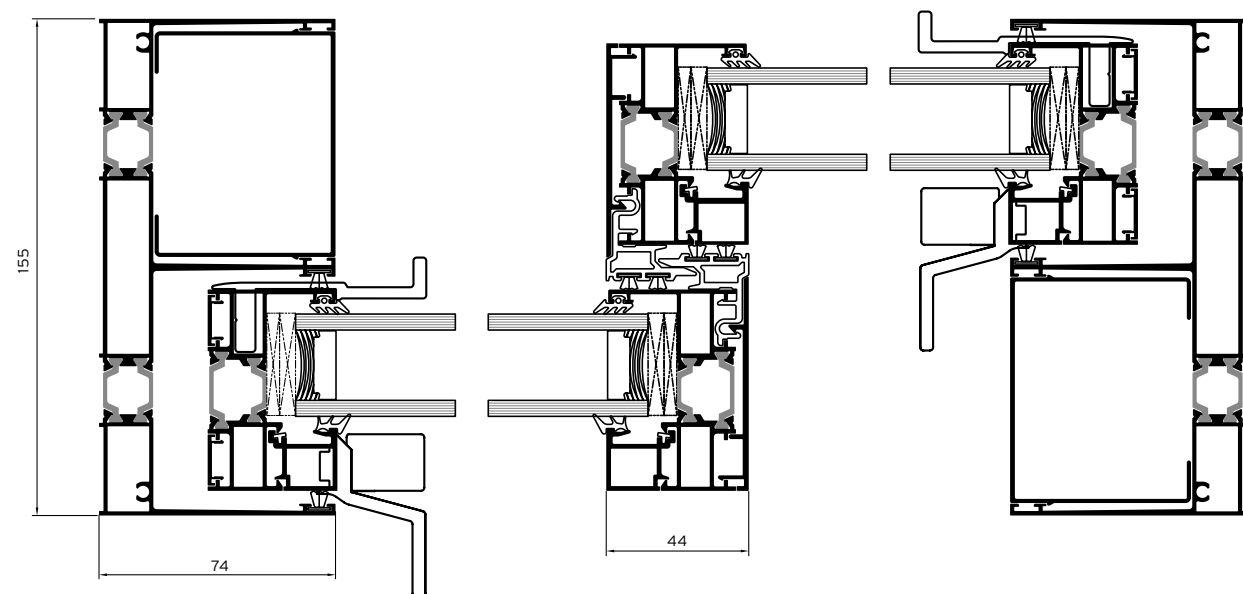
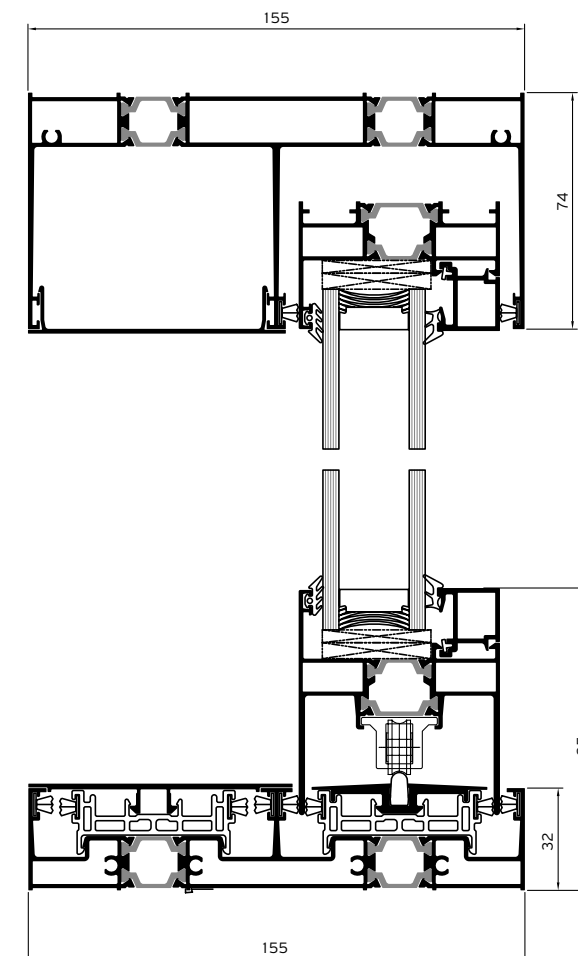
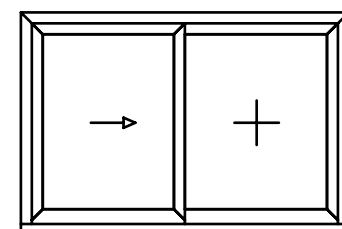
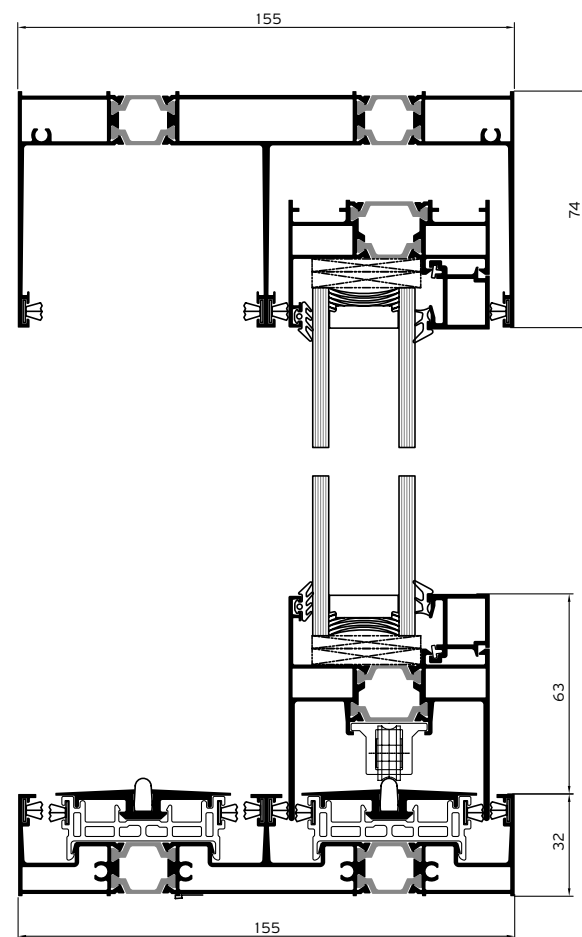
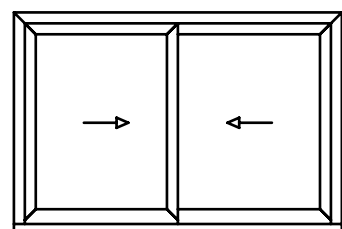

**3 Sashes / 3 Track**

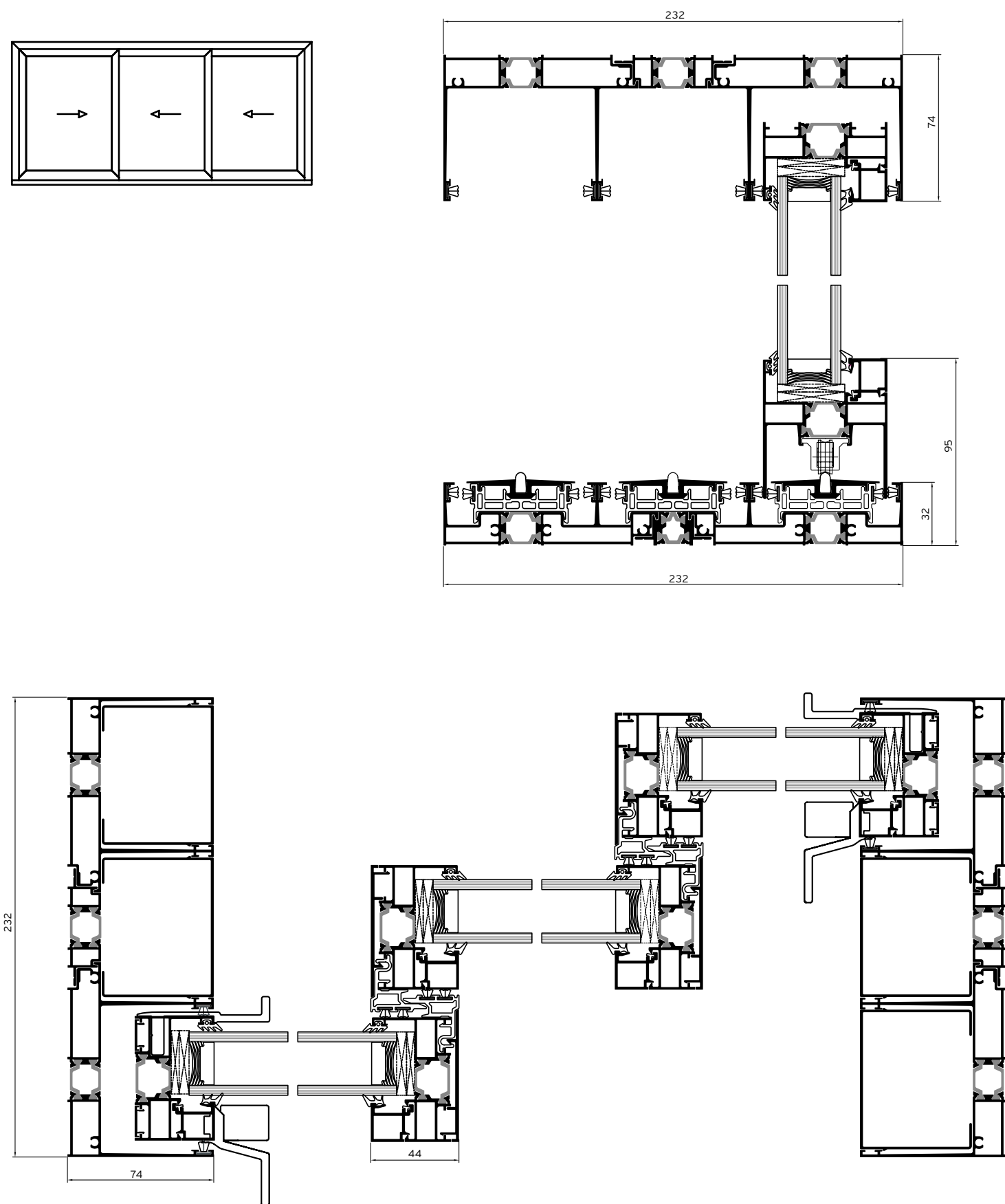

**2 Sashes / 2 Fixed lights / 2 Track**

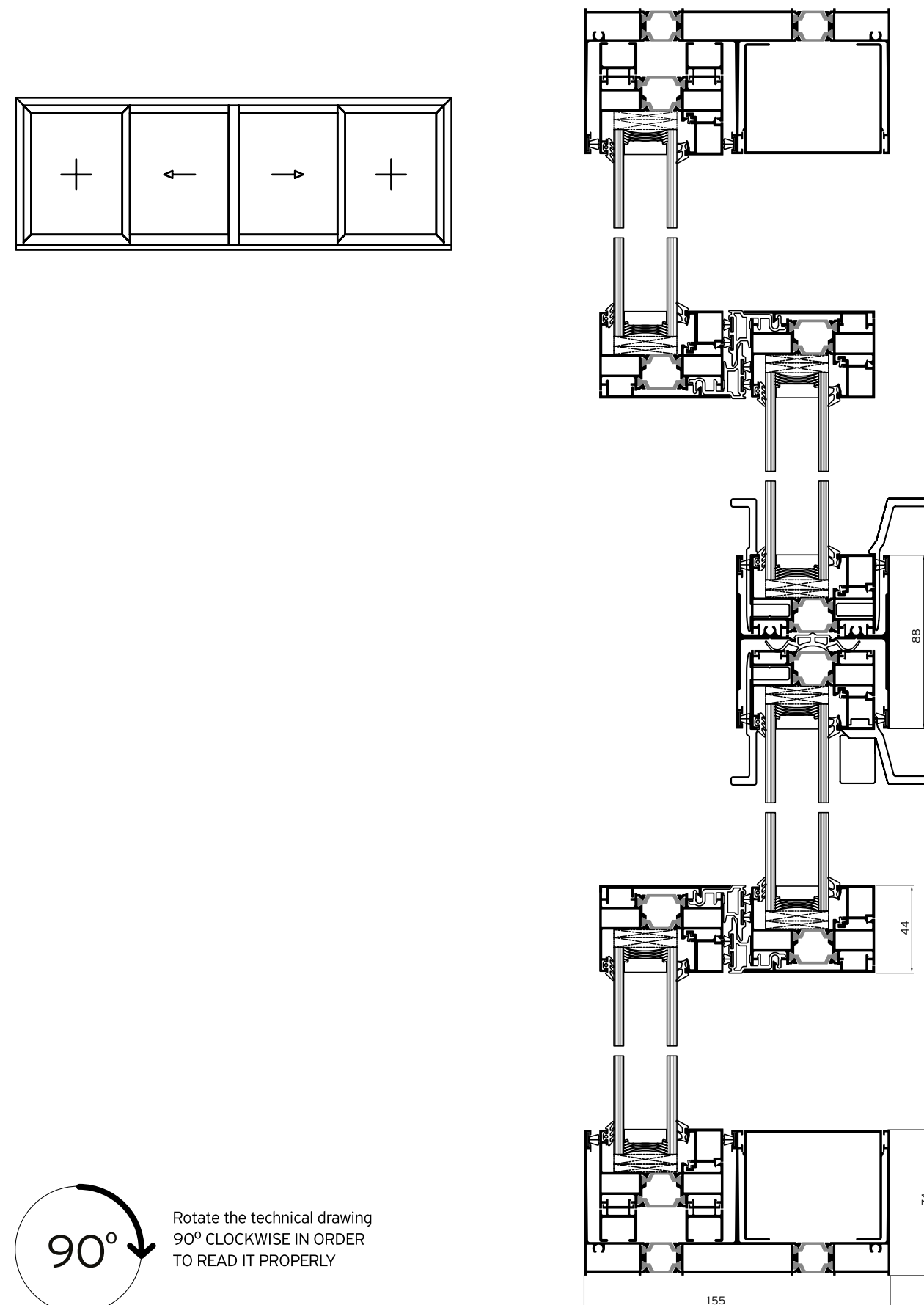

90°  
Rotate the technical drawing  
90° CLOCKWISE IN ORDER  
TO READ IT PROPERLY

### 2 Sashes / 2 Track / Flyscreen

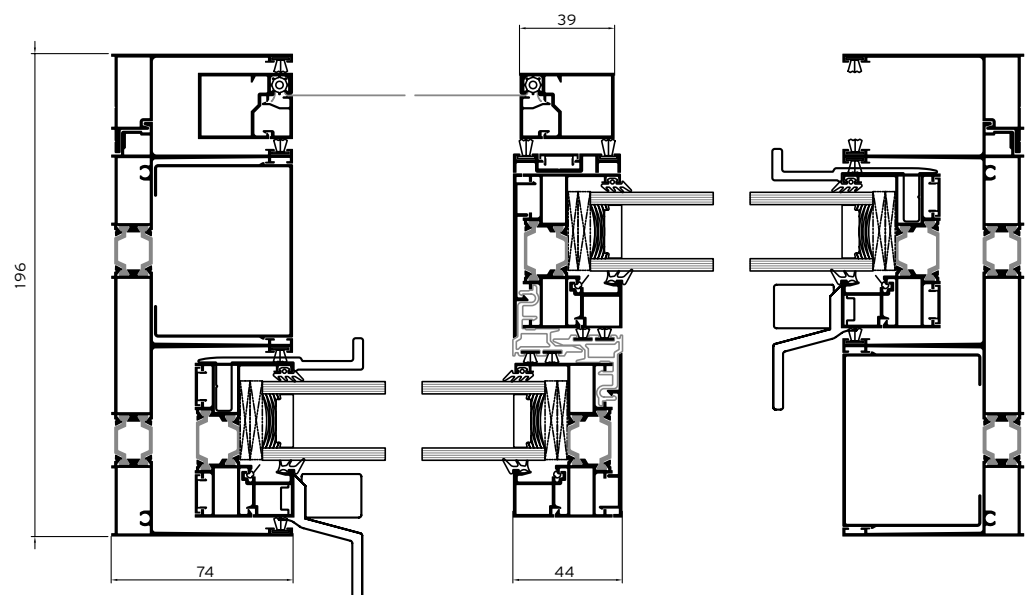
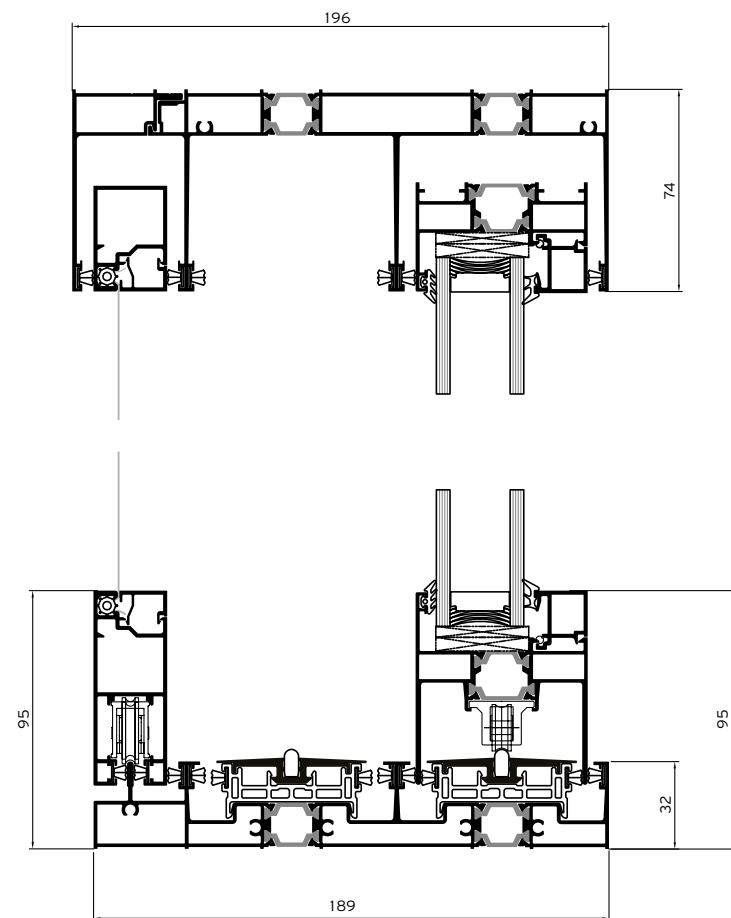
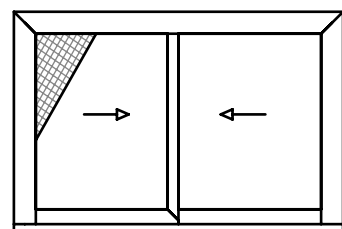

### 4 Sashes / 2 Track / Flyscreen

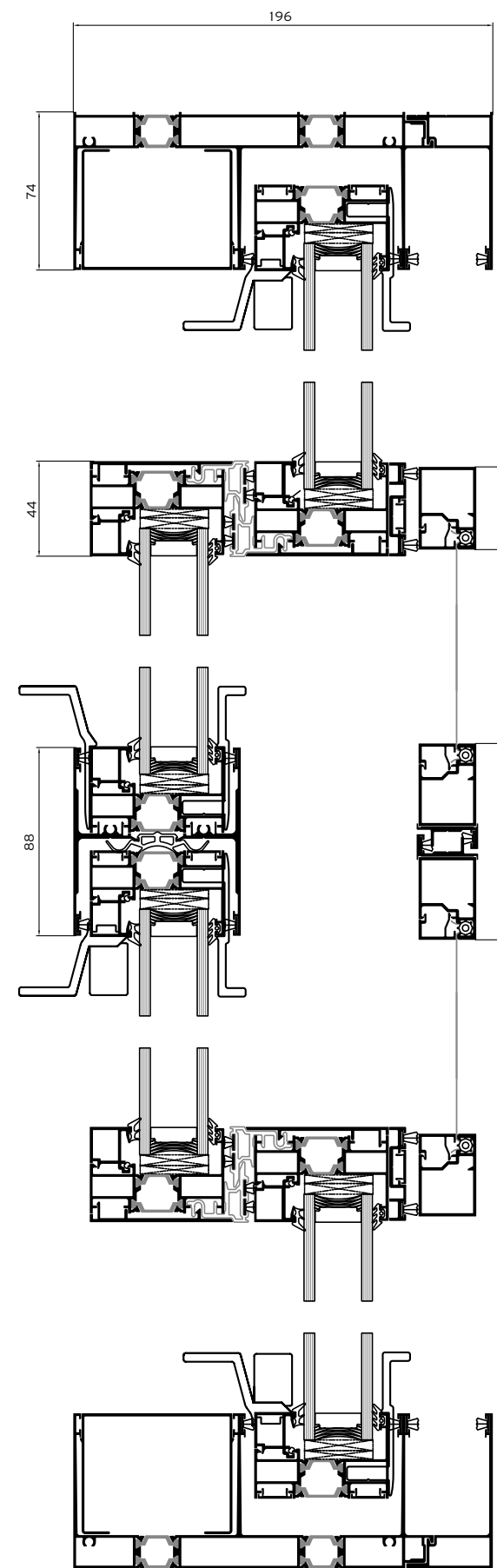
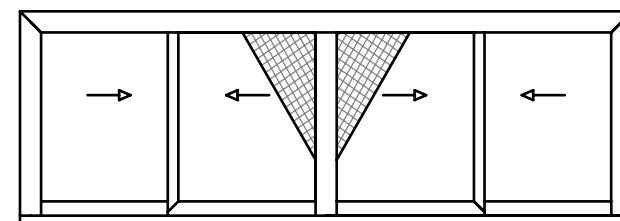

90°  
Rotate the technical drawing  
90° CLOCKWISE IN ORDER  
TO READ IT PROPERLY

# POCKET WINDOW 1 Sash

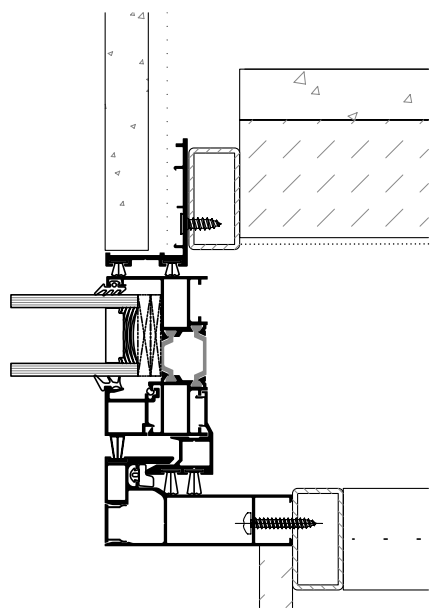
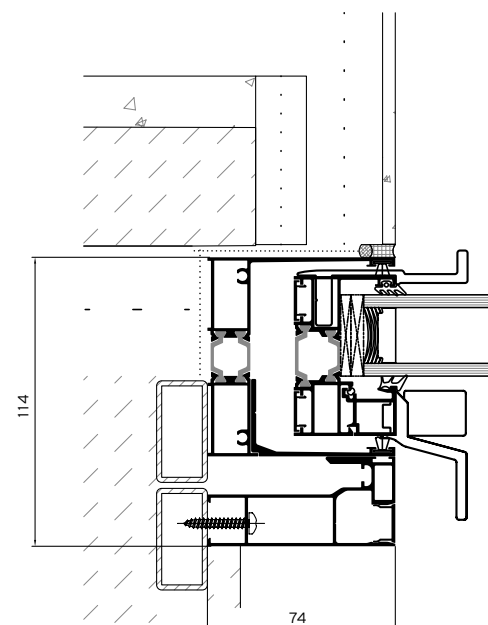
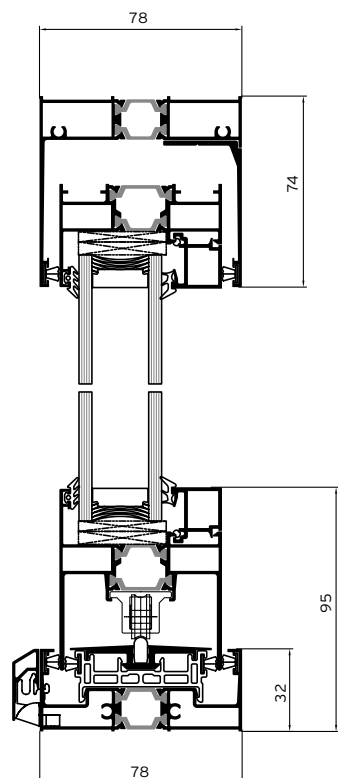
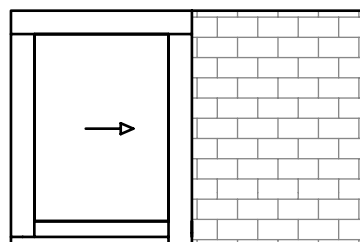

# POCKET WINDOW

# 1 Sash / Flyscreen

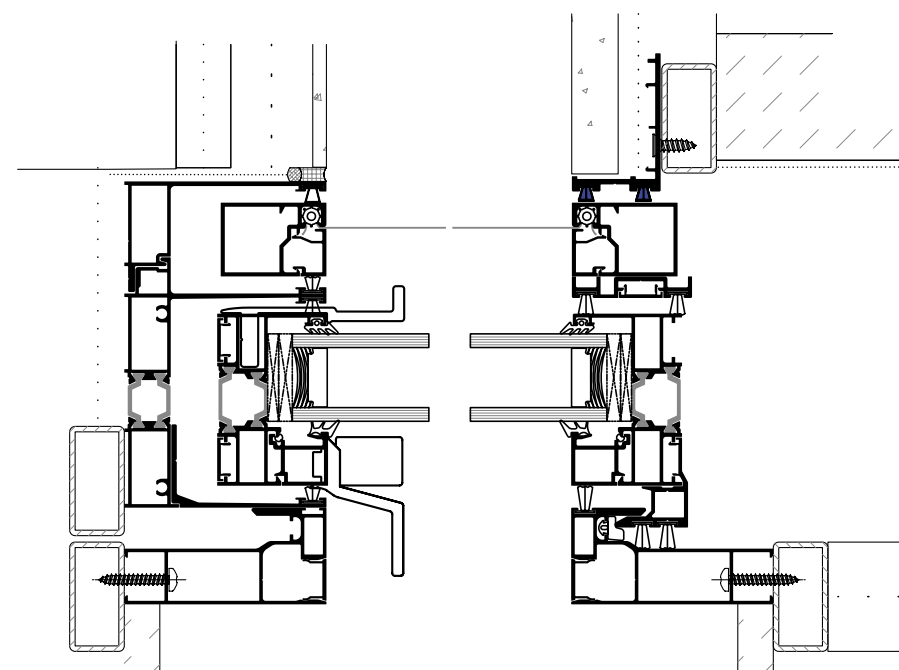
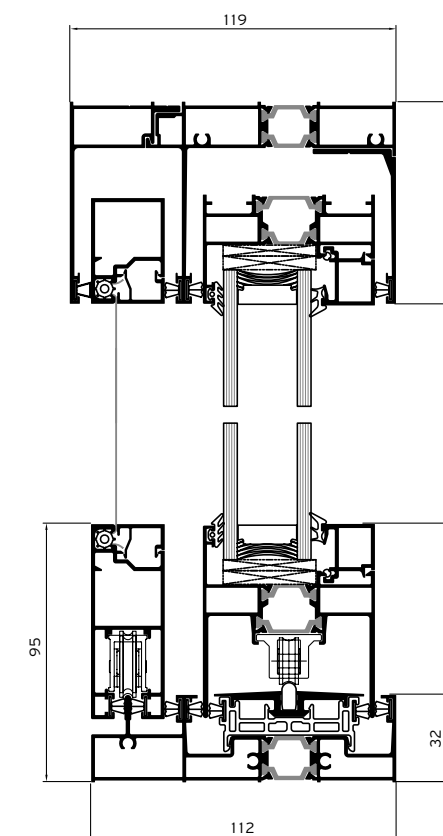
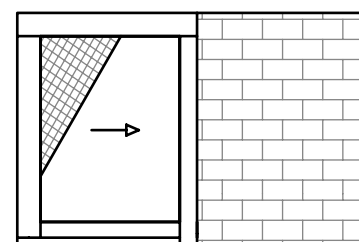

# POCKET WINDOW

## 2 Sashes

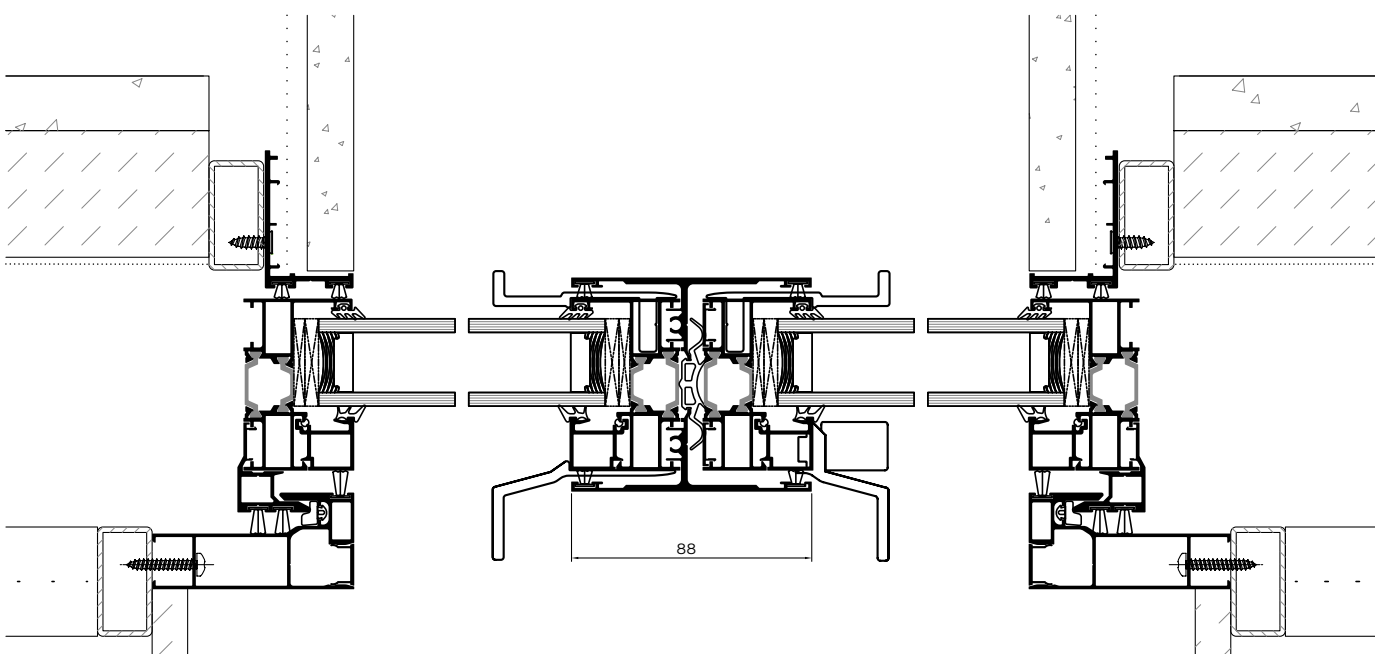
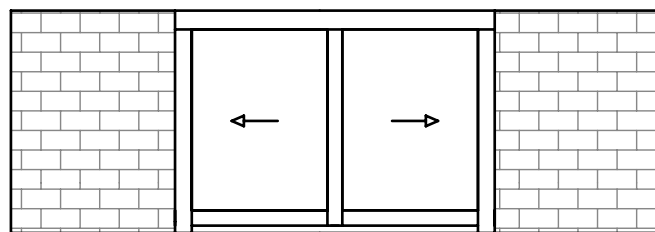

# POCKET WINDOW

## 2 Sashes / Flyscreen

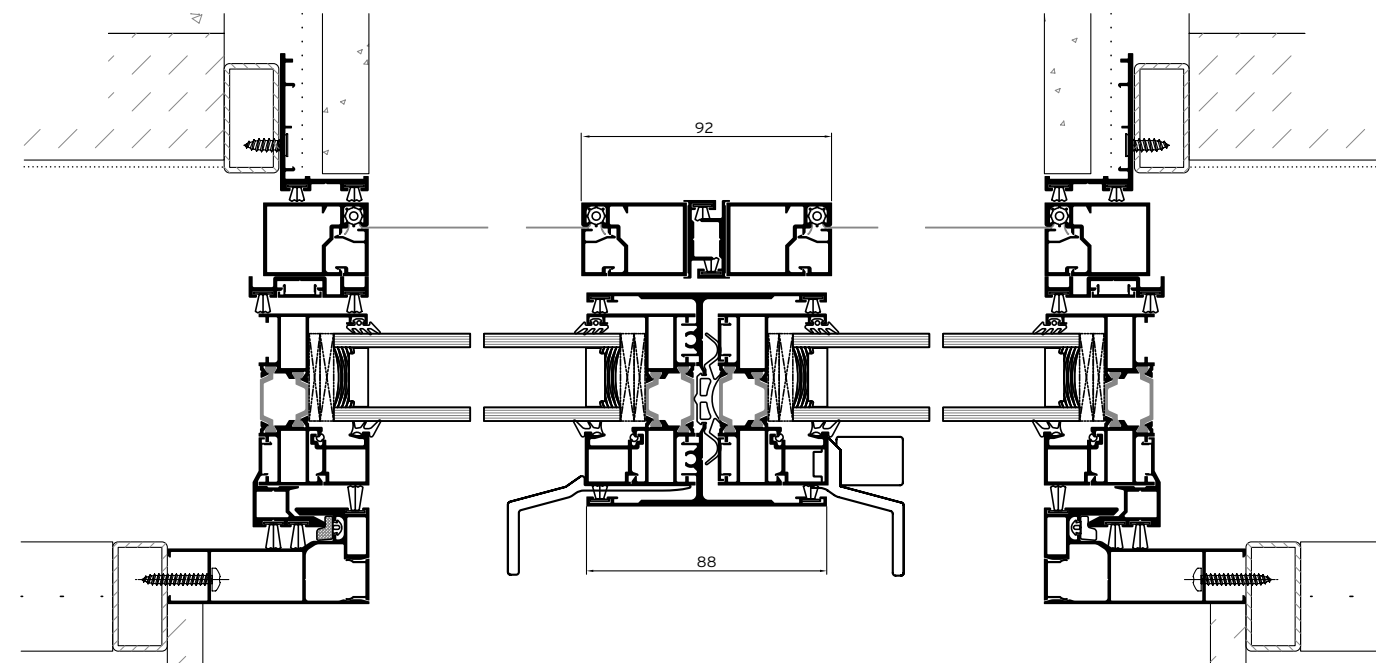
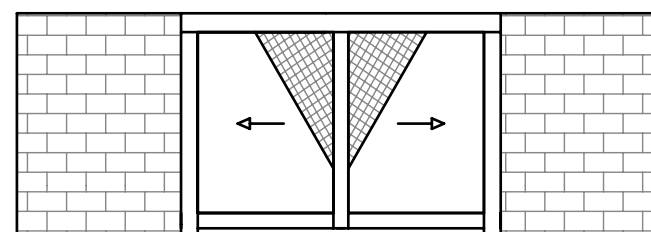

### POCKET WINDOW Multi-Sash

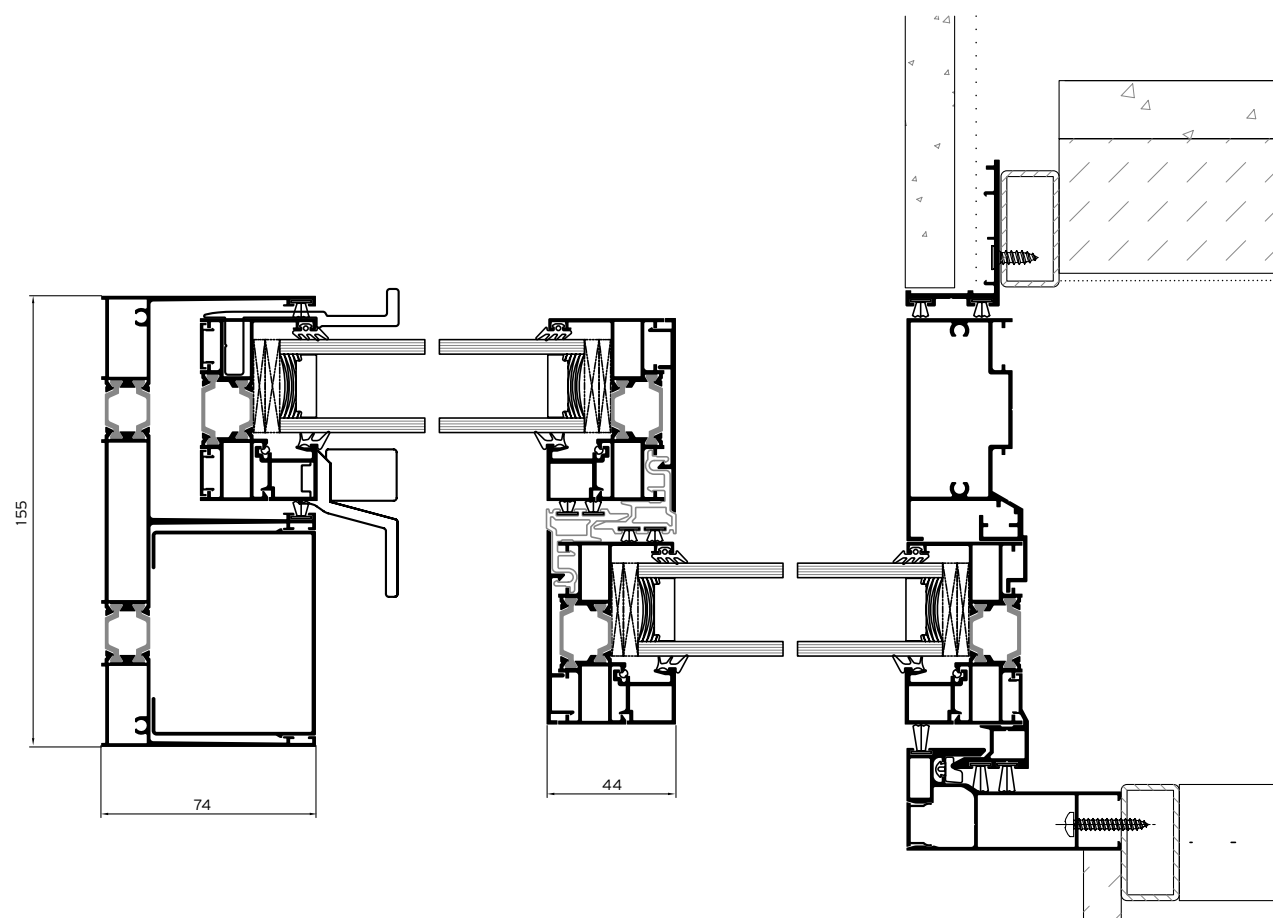
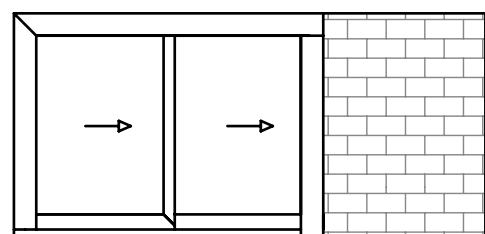



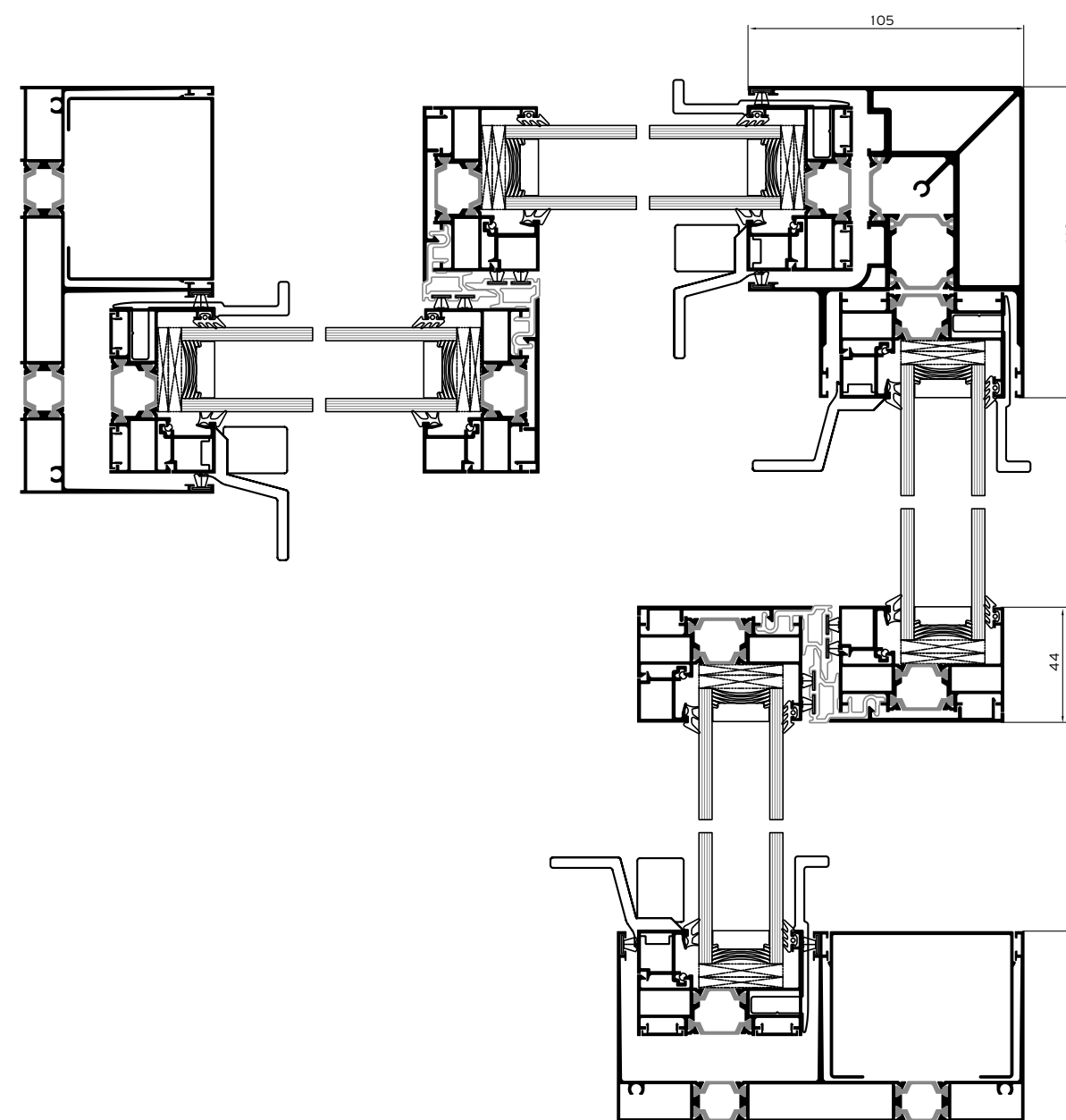
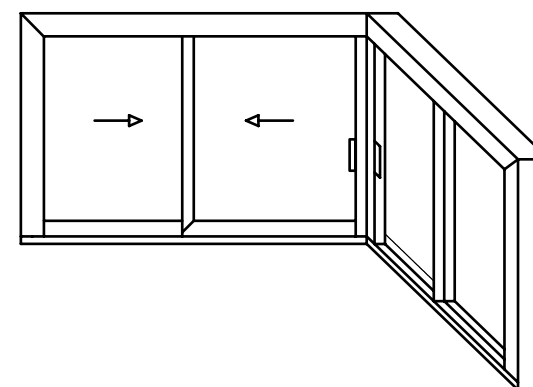









### EXTERNAL CORNER





# Installation

-  PRECOMPRESSED MULTI-FUNCTION SEALING TAPE
-  BACKER ROD
-  HYBRID SEALANT OR NEUTRAL SILICONE
-  STYRODUR HIGH DENSITY BOARD
-  TILES
-  MARBLE
-  POLYURETHANE FOAM
-  POLYSTYRENE
-  WALL CONSTRUCTION
-  WALL FINISH
-  REINFORCED CONCRETE
-  AIR WATER VAPOR BARRIER TAPE

SIDE SECTION

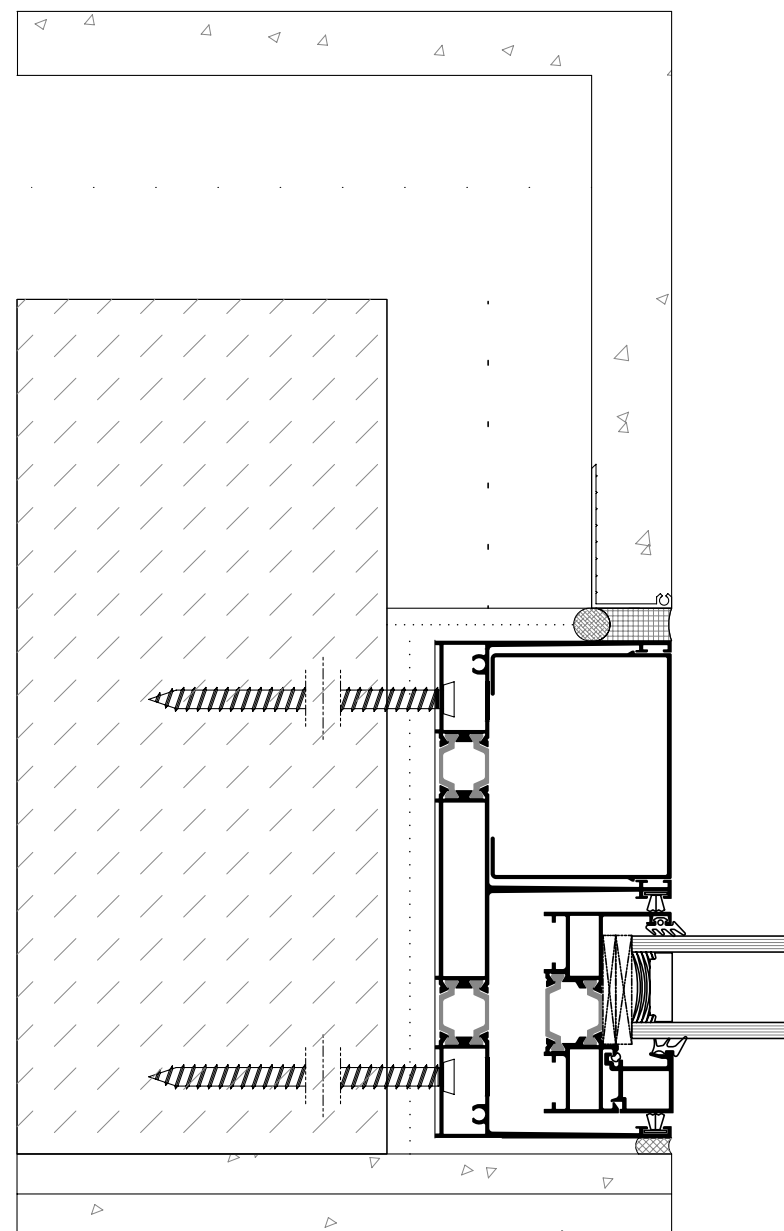

TOP SECTION

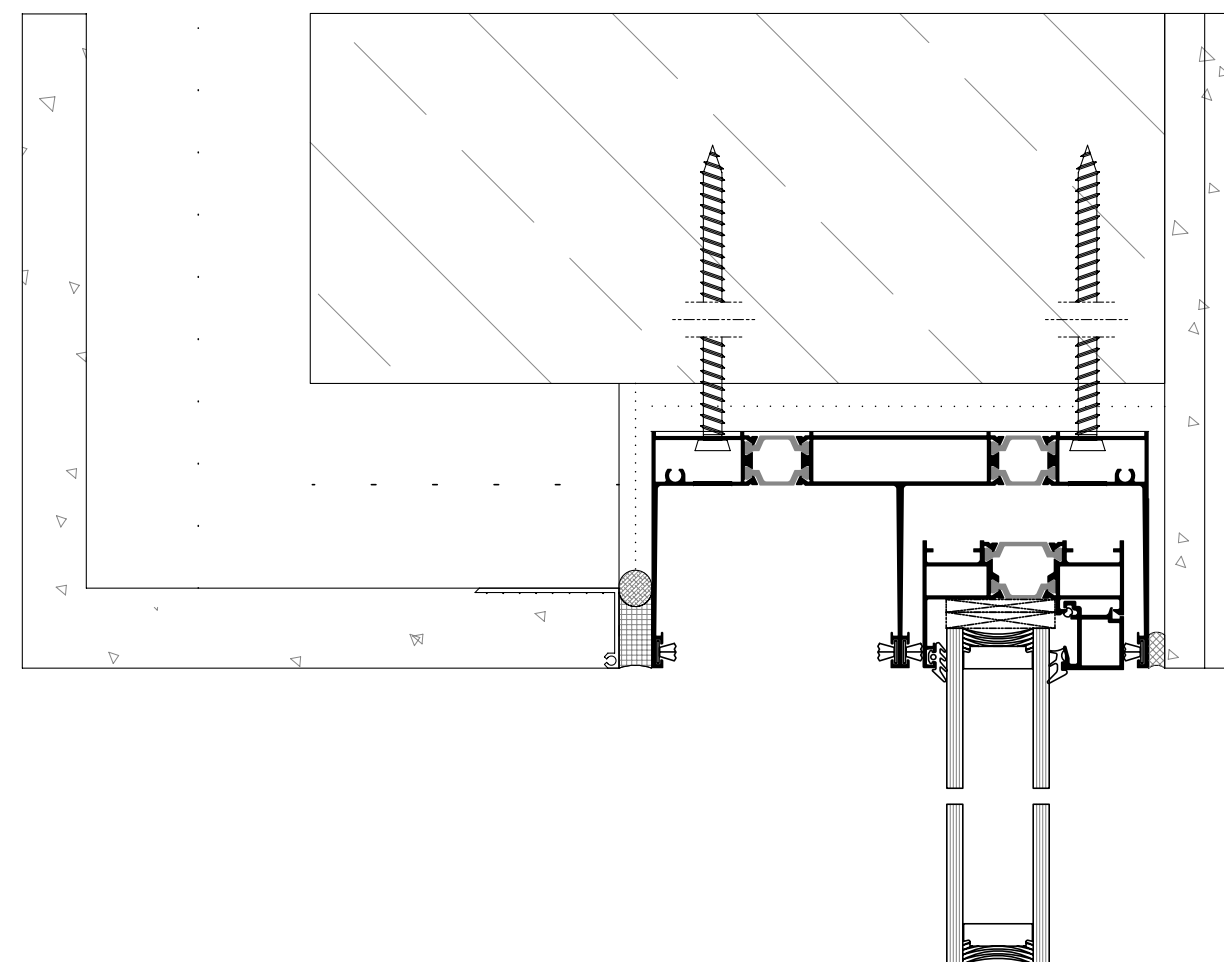

# Installation

BOTTOM SECTION WITH GUTTER

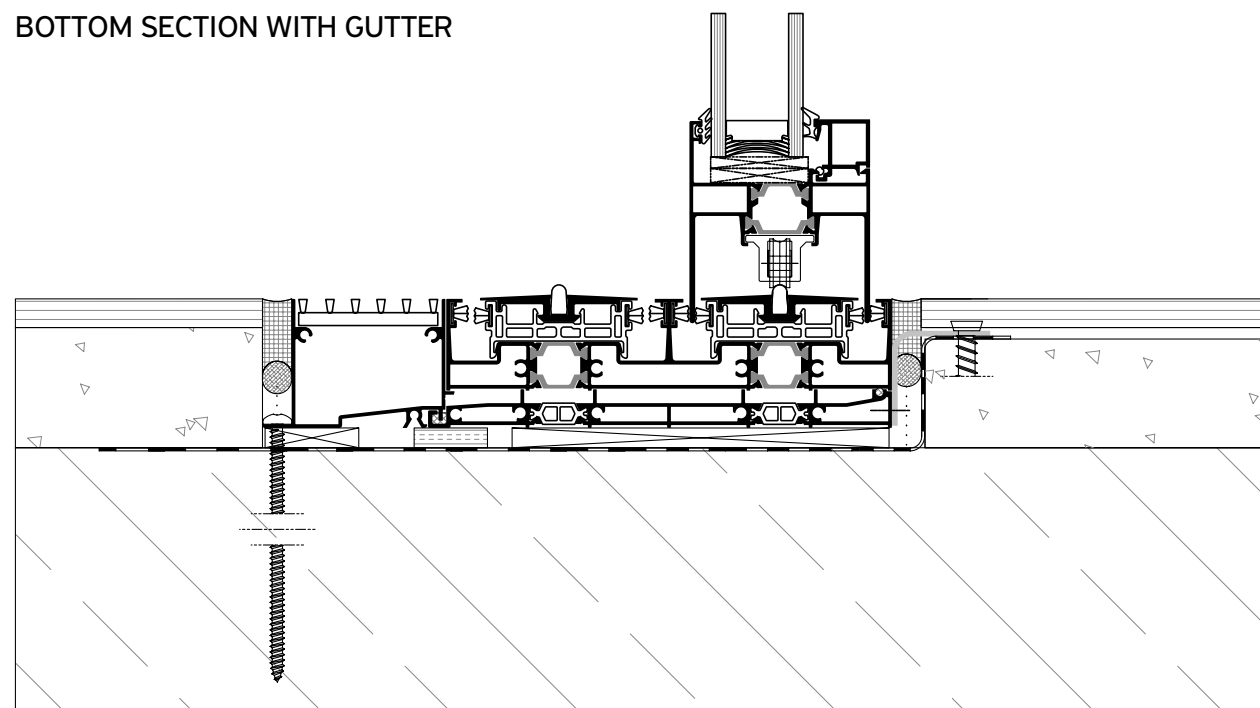

BOTTOM SECTION

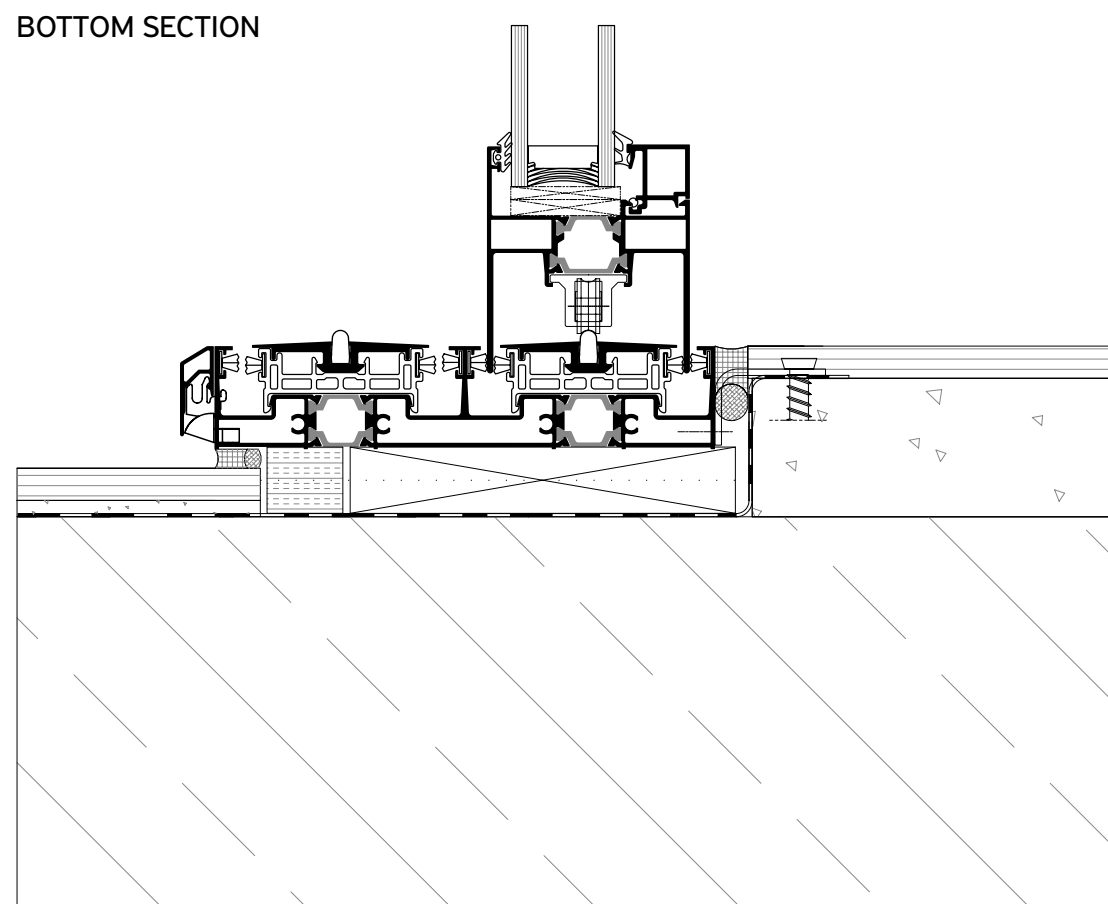

# Applications

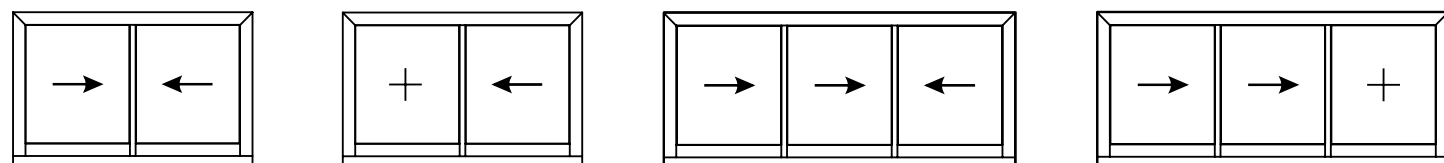

DOUBLE HORIZONTAL SLIDING SASH

SINGLE SLIDING SASH WITH FIXED LIGHT

TRIPLE HORIZONTAL SLIDING SASH

TWO HORIZONTAL SLIDING SASHES WITH FIXED LIGHT

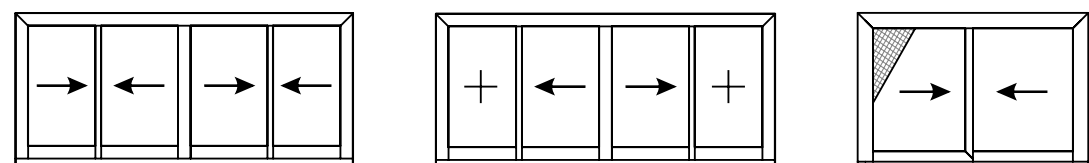

FOUR HORIZONTAL SLIDING SASHES WITH MEETING STILE

DOUBLE HORIZONTAL SLIDING SASH MEETING STILE WITH FIXED LIGHTS

DOUBLE HORIZONTAL SLIDING SASH WITH FLYSCREEN

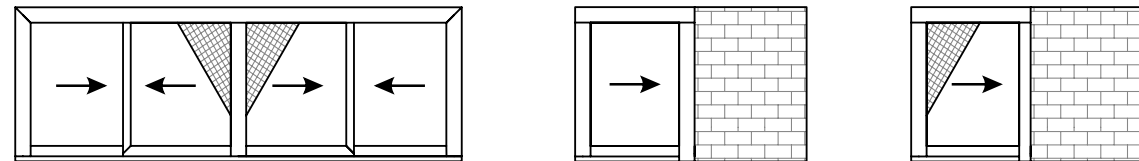

FOUR HORIZONTAL SLIDING SASHES MEETING STILE WITH FLYSCREEN

SINGLE POCKET SASH

SINGLE POCKET SASH WITH FLYSCREEN

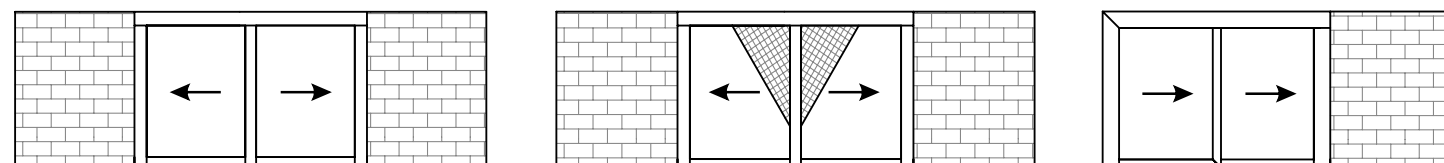

DOUBLE POCKET SASH MEETING STILE

DOUBLE POCKET SASH MEETING STILE WITH FLYSCREEN

MULTI POCKET SASH

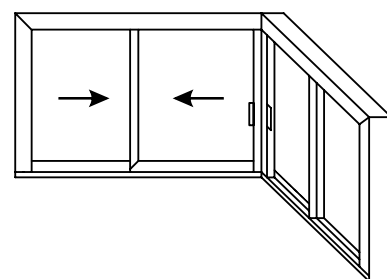

CORNER TYPOLOGY

# Table of performance

**CERTIFICATION**

	<b>WATER TIGHTNESS</b> EN 12208
	<b>AIR PERMEABILITY</b> EN 12207
	<b>WIND LOAD RESISTANCE</b> MAX TEST PRESSURE EN 12210
	<b>WIND LOAD RESISTANCE</b> TO FRONTAL DEFLECTION EN 12210
	<b>SOUND REDUCTION</b> EN ISO 140-3

**CLASSIFICATION**

1A (0 Pa)	2A (50 Pa)	3A (100 Pa)	4A (150 Pa)	5A (200 Pa)	6A (250 Pa)	<b>7A</b> <b>(300 Pa)</b>	8A (450 Pa)	9A (600 Pa)
1		2		3		<b>4</b>		
1 (400 Pa)		2 (800 Pa)		3 (1200 Pa)		4 (1600 Pa)		<b>5</b> <b>(2000 Pa)</b>
A (≤ 1/150)				B (≤ 1/200)			<b>C</b> <b>(≤ 1/300)</b>	

Rw (C;Ctr) = 42 dB depending from the glazing type

**THERMAL PERFORMANCE**

**DIMENSIONS IN MM**  
(w x h)

**U<sub>w</sub> in W/m<sup>2</sup>K**  
(U<sub>g</sub> = 0,6)

**U<sub>w</sub> in W/m<sup>2</sup>K**  
(U<sub>g</sub> = 0,8)

**U<sub>w</sub> in W/m<sup>2</sup>K**  
(U<sub>g</sub> = 1,1)

2 SASHES / 2 TRACK	2300 x 2180	1,12	1,30	1,55
3 SASHES / 3 TRACK	2450 x 2180	1,14	1,32	1,58
4 SASHES / 2 TRACK	4600 x 2180	1,12	1,30	1,55

www.alumil.com

DISCOVER MORE:



**ALUMIL  
MIDDLE EAST DMCC**

MAZAYA BUSINESS AVENUE BB1  
29TH FLOOR, OFFICE #2907  
JUMEIRAH LAKES TOWERS, DUBAI, UAE  
TEL.: +971 4 4425930  
FAX: +971 4 4416528  
EMAIL: marketing.uae@alumil.com  
[www.alumil.ae](http://www.alumil.ae)

**ALUMIL  
HEADQUARTERS**

KILKIS INDUSTRIAL AREA  
KILKIS - GR 61100  
TEL.: +30 23410 79300  
FAX.: +30 23410 71988  
E-MAIL: info@alumil.com



**ALUMIL  
MIDDLE EAST DMCC**

MAZAYA BUSINESS AVENUE BB1  
29TH FLOOR, OFFICE #2907  
JUMEIRAH LAKES TOWERS,  
DUBAI, UAE

**TEL.:** +971 4 4425930

**FAX:** +971 4 4416528

**EMAIL:** marketing.uae@alumil.com

**ALUMIL  
HEADQUARTERS**

KILKIS INDUSTRIAL AREA  
KILKIS - GR 61100

**TEL.:** +30 23410 79300

**FAX.:** +30 23410 71988

**E-MAIL:** info@alumil.com

**[www.alumil.ae](http://www.alumil.ae)**



**alumil**