



Alumil
Building excellence every day

Alumil > SMARTIA
Barcode Cladding



CONTENTS

SMARTIA BARCODE CLADDING

INTRODUCTION	4
DECORATIVE SOLUTIONS	
/ ALUMINIUM PROFILES	8
/ WOODALUX®	10
/ LIGHTING	12
/ PERFORATION	14
HOLISTIC BARCODE EXPERIENCE	18
ALUMINIUM SUBFRAME	20
APPLICATIONS & TYPOLOGIES	22



SMARTIA BARCODE CLADDING

is the ideal series for wall-cladding applications and undoubtedly an astonishingly useful tool for architects, contributing to the design of impressive constructions, and fully or partially covering buildings in a unique style.

Create Cladding

Façades in Style



- Aimed at covering many types of buildings, i.e., of commercial & office use, as well as modern residences with unlimited possibilities.
- Applied both at the exterior and the interior, on the wall and the ceiling, upgrading overall aesthetics and energy levels.
- Mainly based on a wide selection of aluminium profiles and integrated with other elements, e.g., wood composite Woodalux®, LED lighting, perforated surfaces, etc.
- Facilitates stylish combinations of cladding surfaces with complementary fences, gates, shutters, shading surfaces, and more, all designed in harmony.



Top aesthetics - **modern minimalistic** constructions, which create new architectural trends.

INCOMPARABLE

- **Innovation** – high levels of differentiation and very interesting architectural proposals.
- **Robust construction** – very large surfaces can be covered, thanks to the integrated support system, made also of aluminium.
- **Resistance** – extreme corrosion resistance, thanks to the durability of aluminium and its surface treatment.

ADVANTAGES

- **Insulation** – it allows and at the same time protects the thermal insulation regardless of its thicknesses.
- **Technical applications** – it provides efficient solutions, even in cases characterized by technical complexity (cladding with curtain walls, windows, etc).
- **Decoration** - unlimited color choices, combined with LED lighting options and synthetic wood (Woodalux®).



Insightful projects
require a smart variety
of **decorative solutions**

A diverse and continually expanding selection of aluminum profiles is available to satisfy **the aesthetic demands of any project**. Whether symmetric or asymmetric, featuring hollows or flat blades, these profiles firmly interlock, delivering a stylish outcome. Moreover, they can be seamlessly **integrated with LED lighting strips, Woodalux® planks**, and each other, allowing for even greater creative possibilities in design.



DECORATIVE SOLUTIONS

ALUMINIUM PROFILES

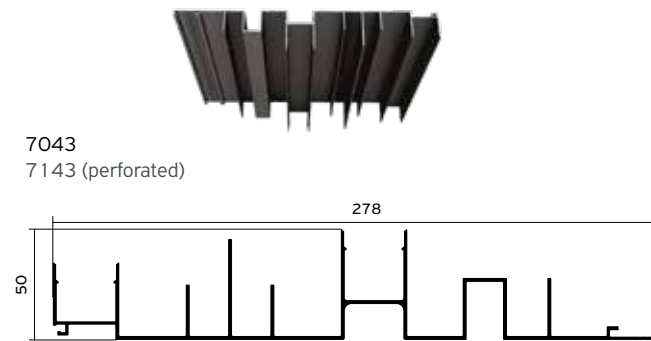

7043
7143 (perforated)

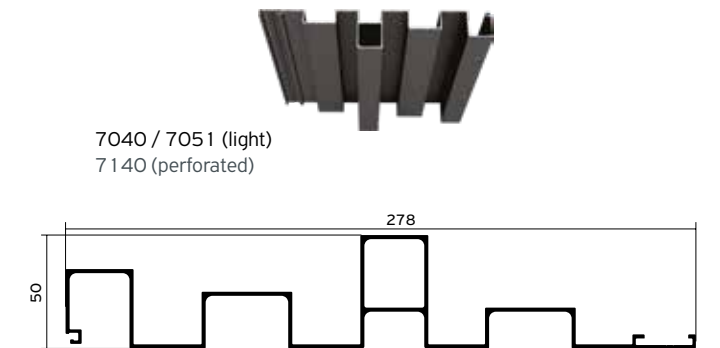

7040 / 7051 (light)
7140 (perforated)

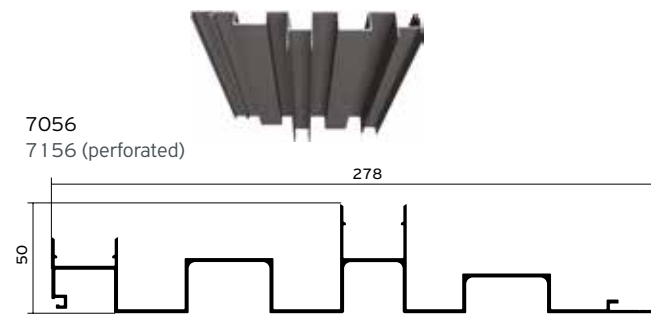

7056
7156 (perforated)

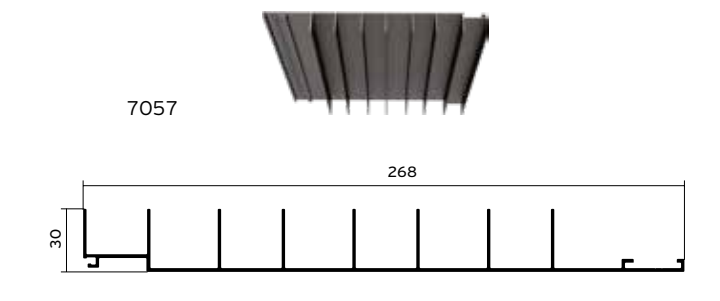

7057

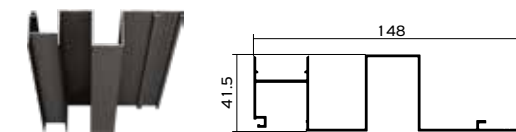

7055
7155 (perforated)

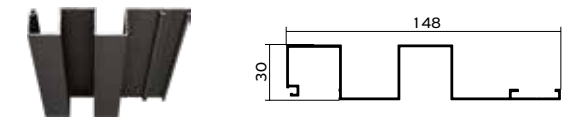

7045
7145 (perforated)

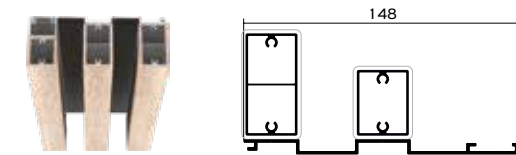

7037
7137 (perforated)

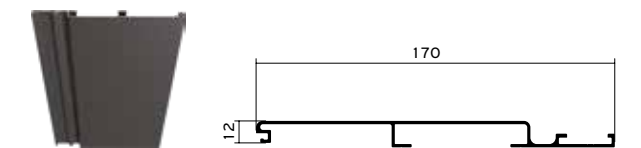

7063

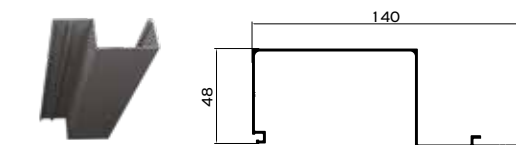

7070

Innovative architectural solutions need **innovative building materials**



DECORATIVE SOLUTIONS

WOODALUX®



Aluminium profile, capped with wood-composite material, a multi-use building material, **suitable for long lasting decorative** constructions that naturally upgrade the buildings.

- It outperforms wood when used outdoors, exhibiting superior resistance to weather conditions, direct sunlight, and factors that cause wood decay, requiring no maintenance.
- Fixed on a special flat profile or combined with the other cladding profiles, Woodalux® offers stylish creations.
- Available in various dimensions (32x40, 32x60, 32x80, 32x120 mm), nine colors and caps of the same material or aluminium material.

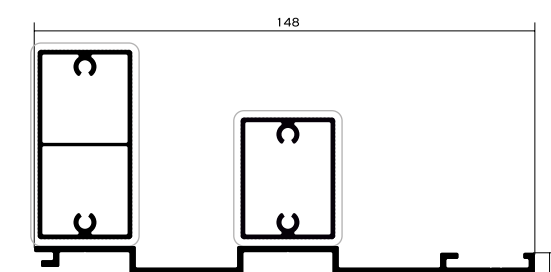

DECORATIVE SOLUTIONS

LIGHTING

Experience the numerous lighting options and bring **enlightened solutions into life!**

LED lighting strips are seamlessly integrated into the aluminum profiles, enhancing the overall architectural design and offering endless creative customization. With the option for dimmable LED, precise control over brightness levels can be achieved, promoting energy efficiency and allowing for dynamic atmospheres tailored

to any environment or mood. Placed partially or all along the aluminum bars, these lighting options literally transform the cladding surface and the building itself, especially as the sun goes down, further enhancing the visual impact and functionality of the design.

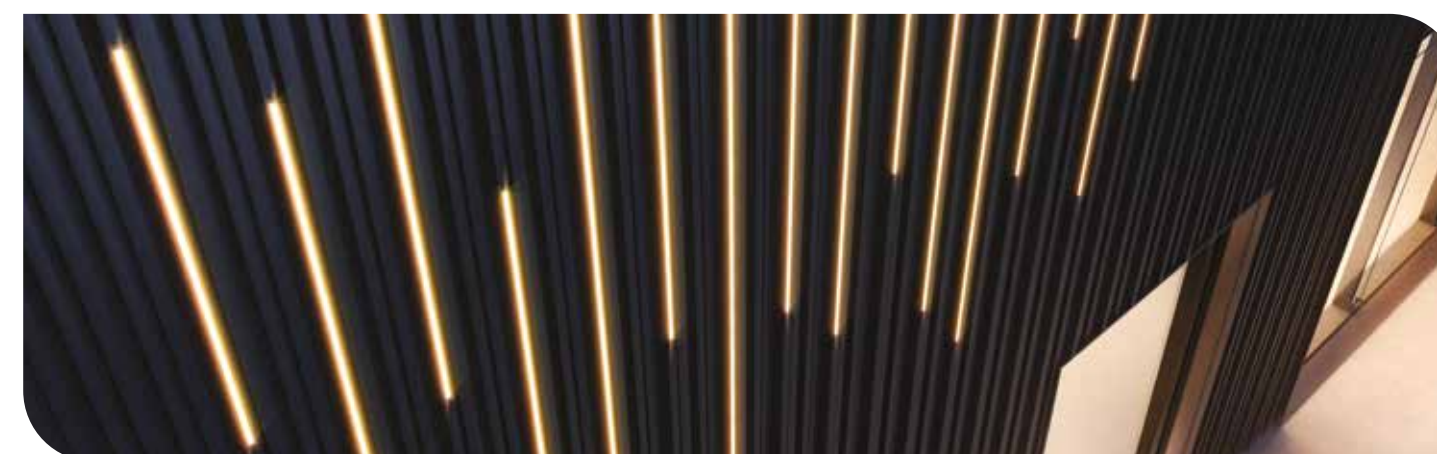
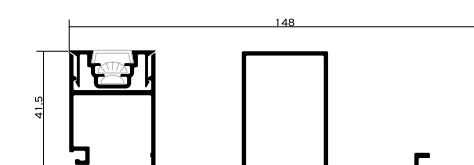
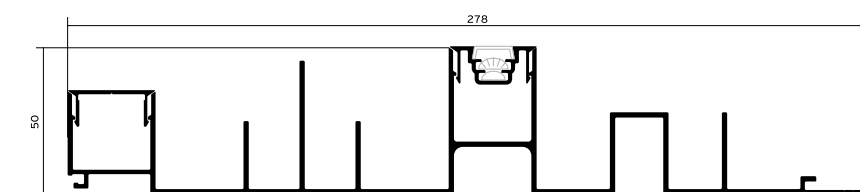
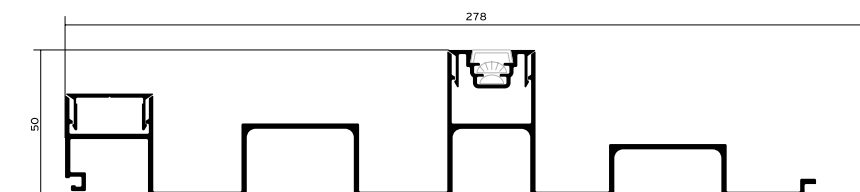

DECORATIVE SOLUTIONS

PERFORATION Exterior

Shedding light
via **perforation**

Perforated profiles **allow the natural lighting during the day** and enhance the extra decorative play with **the artificial lighting during the night.**

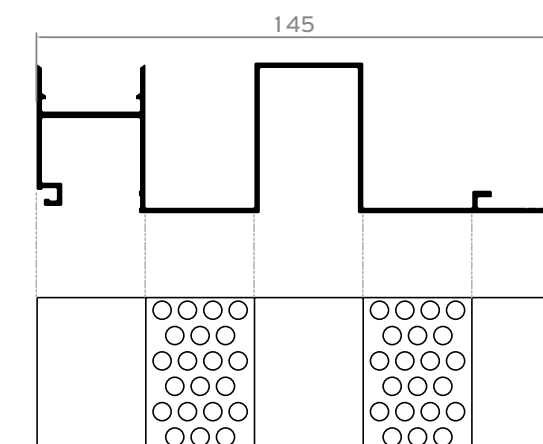
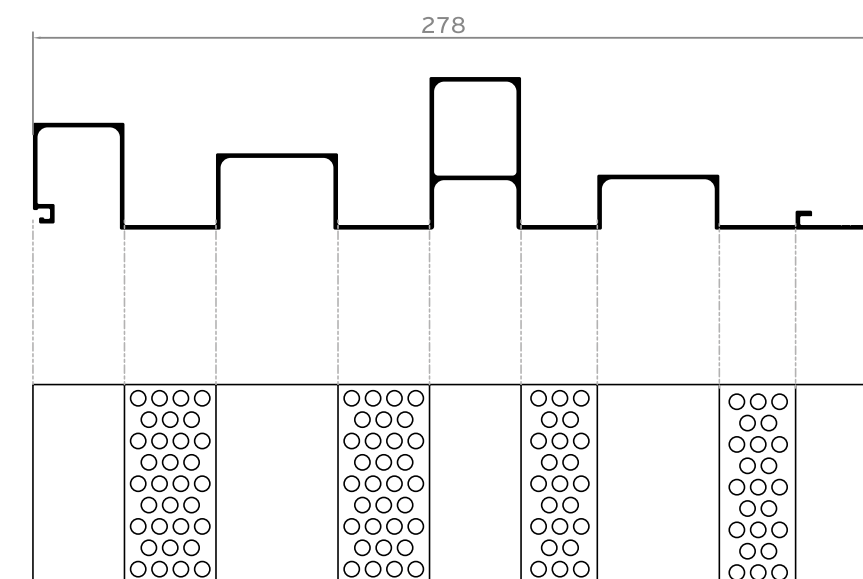
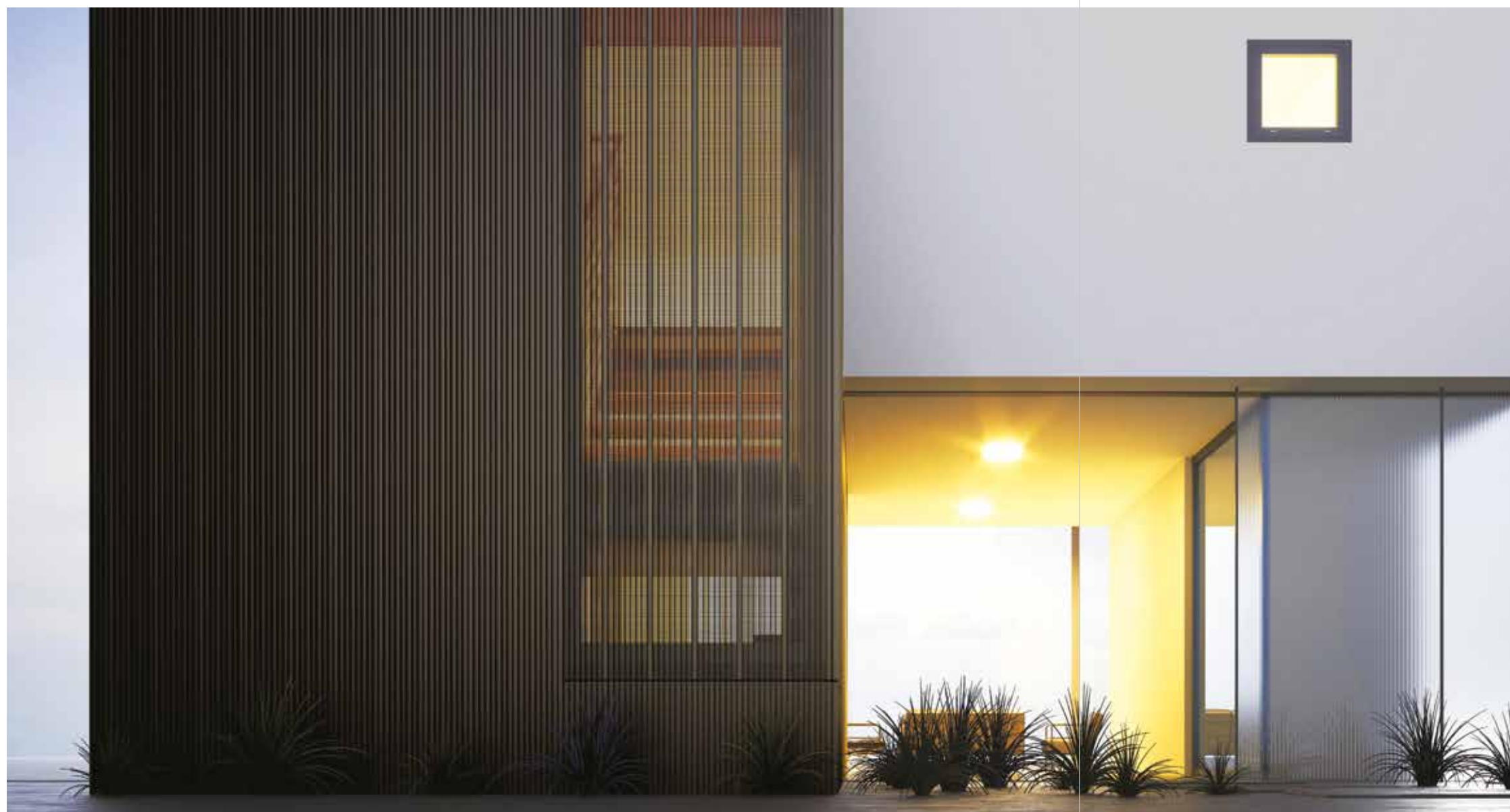
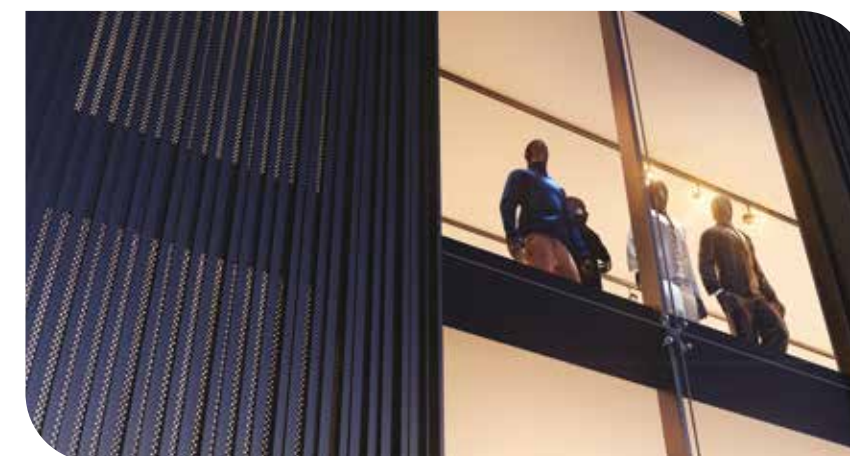

The dense round perforation (5 mm) along the inner channel of the profiles upgrades aesthetics & lighting.



Barcode cladding **applications indoors** on both walls and ceilings. Accompanied by lighting elements and sound reductive on materials, they offer **unique aesthetic** and **sound reduction properties**.

Ceiling application



Wall application



Alumil > SMARTIA
Barcode Cladding

Craft effortlessly elegant outdoor environments by integrating our Barcode design solutions. Our emblematic **gates, stylish fences,** and **shutters** epitomize modernity and durability, elevating outdoor spaces with sophistication. Enhanced by integrated **LED lights** and **Woodalux® bars,** our designs leave a lasting impression and captivate attention.

HOLISTIC BARCODE EXPERIENCE

Fences, gates, shutters & more

/ Spectacular hinged gate with concealed pivot hinges, manual or automated operation, **up to 1.5 m width / 3.0 m height,** if single-leaf.

/ Inspirational sliding / hinged gates and fences, which cover most technical and decorative needs **(up to 2.0m height and 6.0m length).**



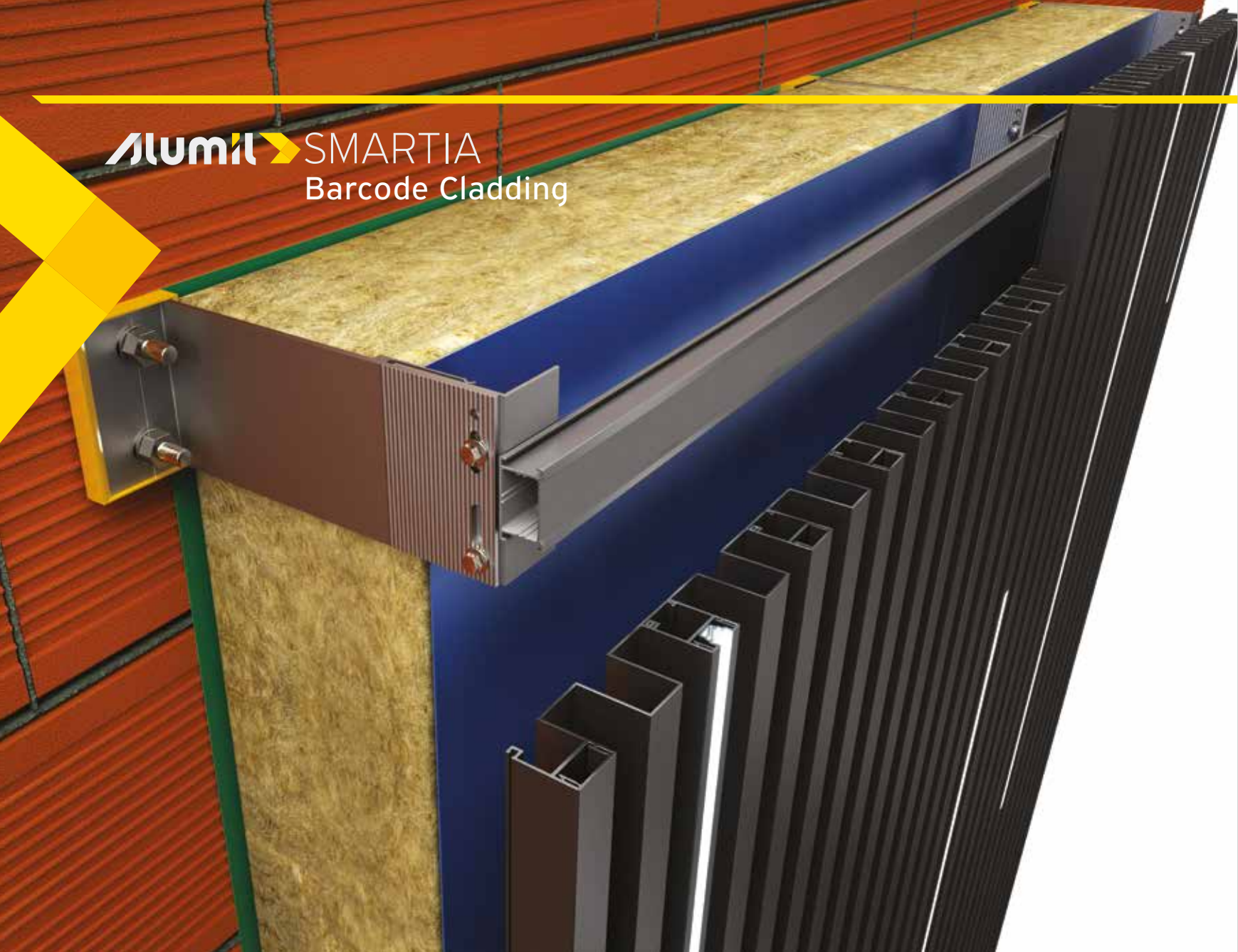

Solution for thermal insulation

The cladding system is accompanied with a robust and efficient aluminium subframe, which allows covering of very large surfaces, without limitation on insulation thickness. Furthermore, **the easy, fast and sturdy installation of the system provides high flexibility during its construction.**

- Great variety of aluminium brackets, to allow insulation thickness up to 200 mm.
- Special clip on the brackets for fast installation.
- Oval pre-made holes for flexible adjustments.
- Durable plastic pad, to avoid thermal bridging.
- Additional transom profiles, to create complex frames and overcome application complexities.
- Compatible with many other wall cladding materials, such as aluminium composite panels and sheets or wood composite planks (Woodee).

ALUMINIUM

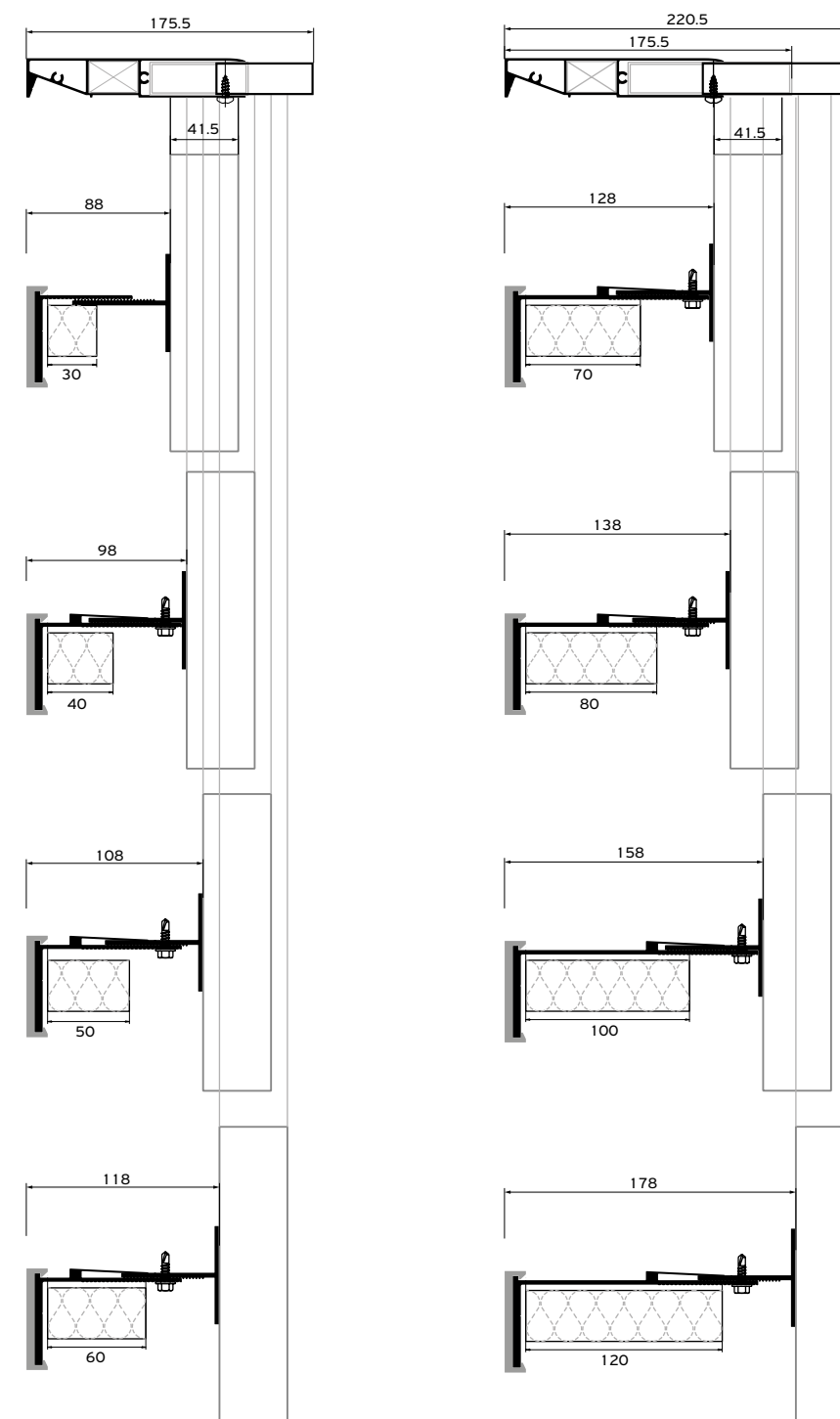

Minimum space 25mm between insulation & cladding material .
Final selection of insulation thickness & bracket size depends on project conditions.

SUBFRAME

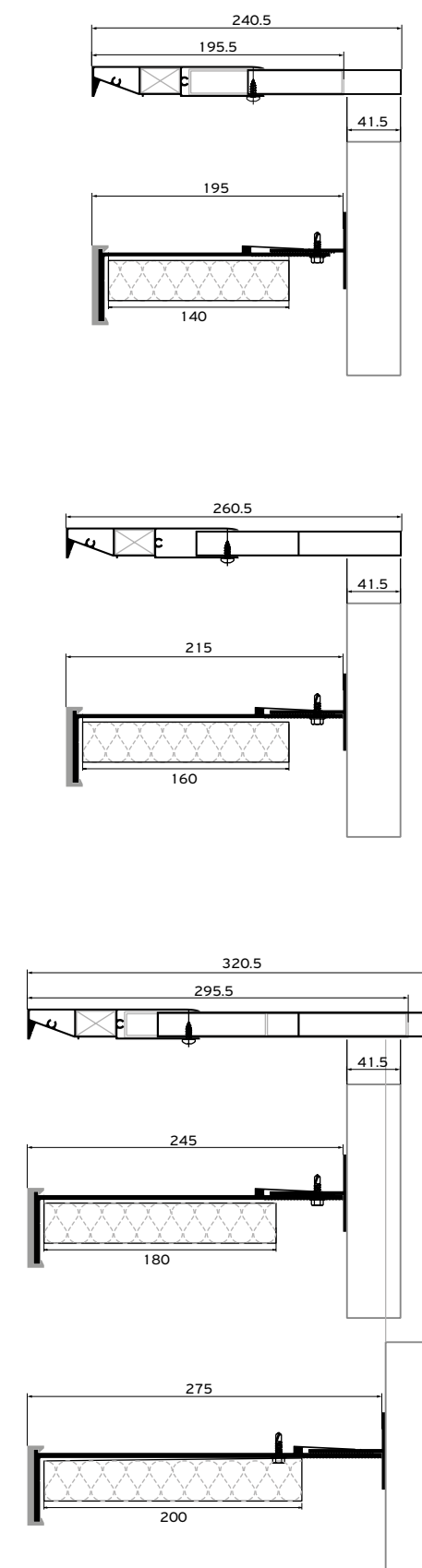

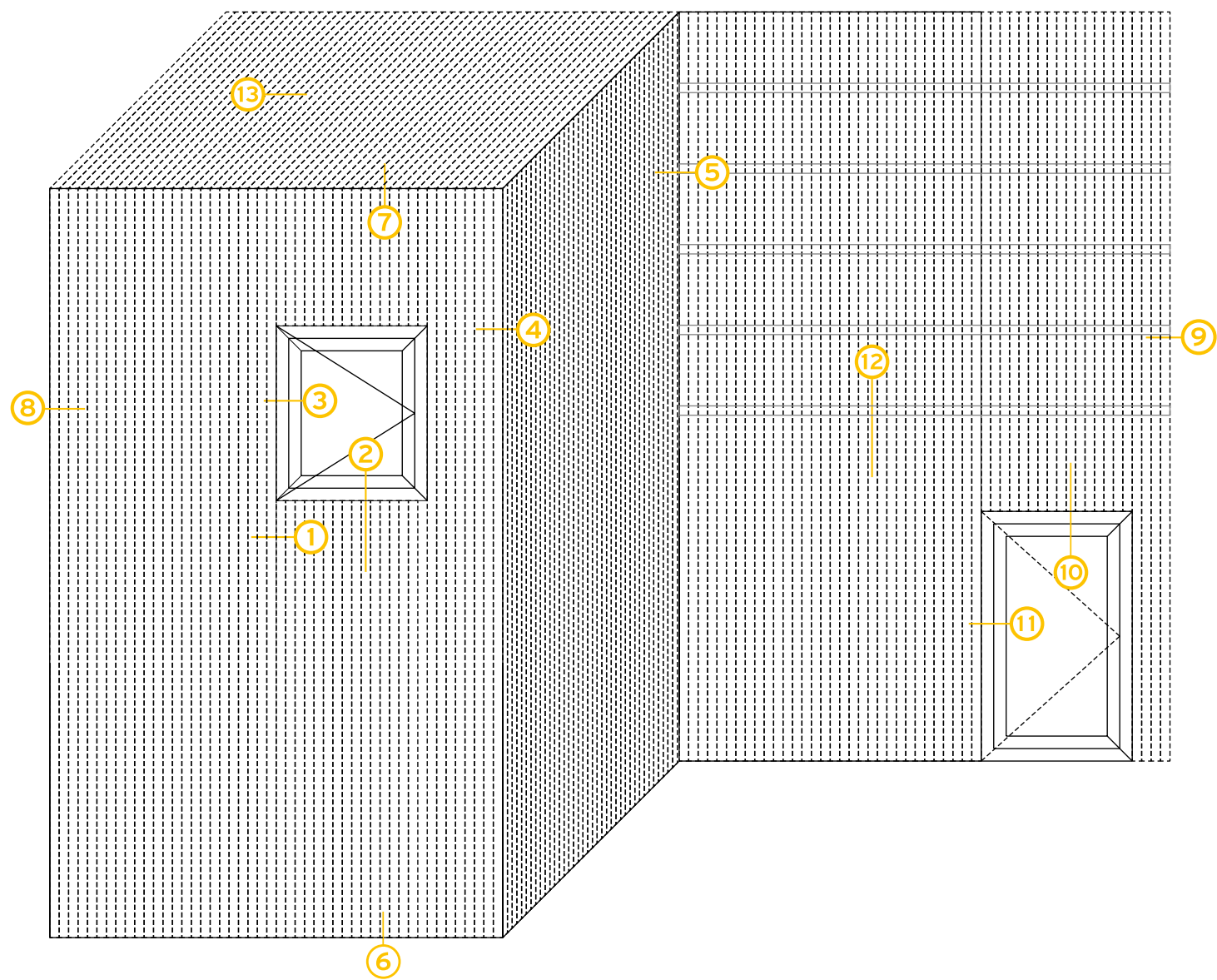

APPLICATIONS

& TYPOLOGIES

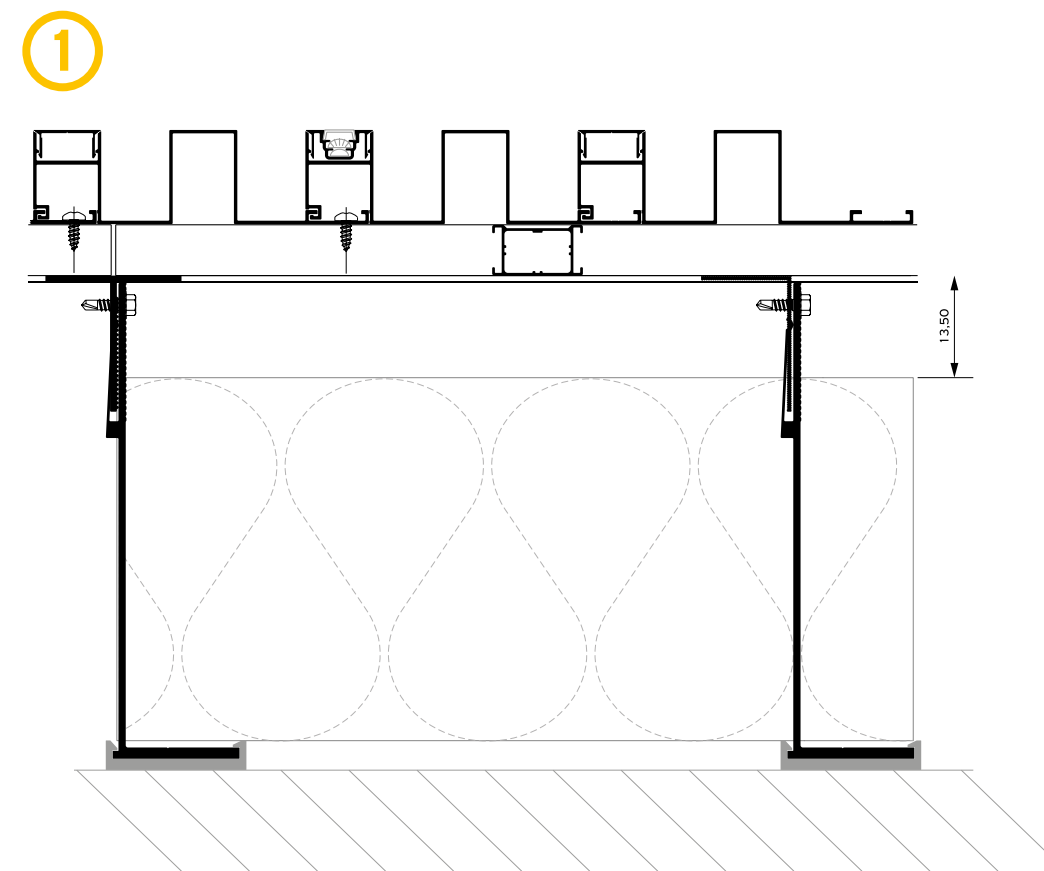

** In lighter constructions, the transom profile can be omitted*

Alumil SMARTIA
Barcode Cladding

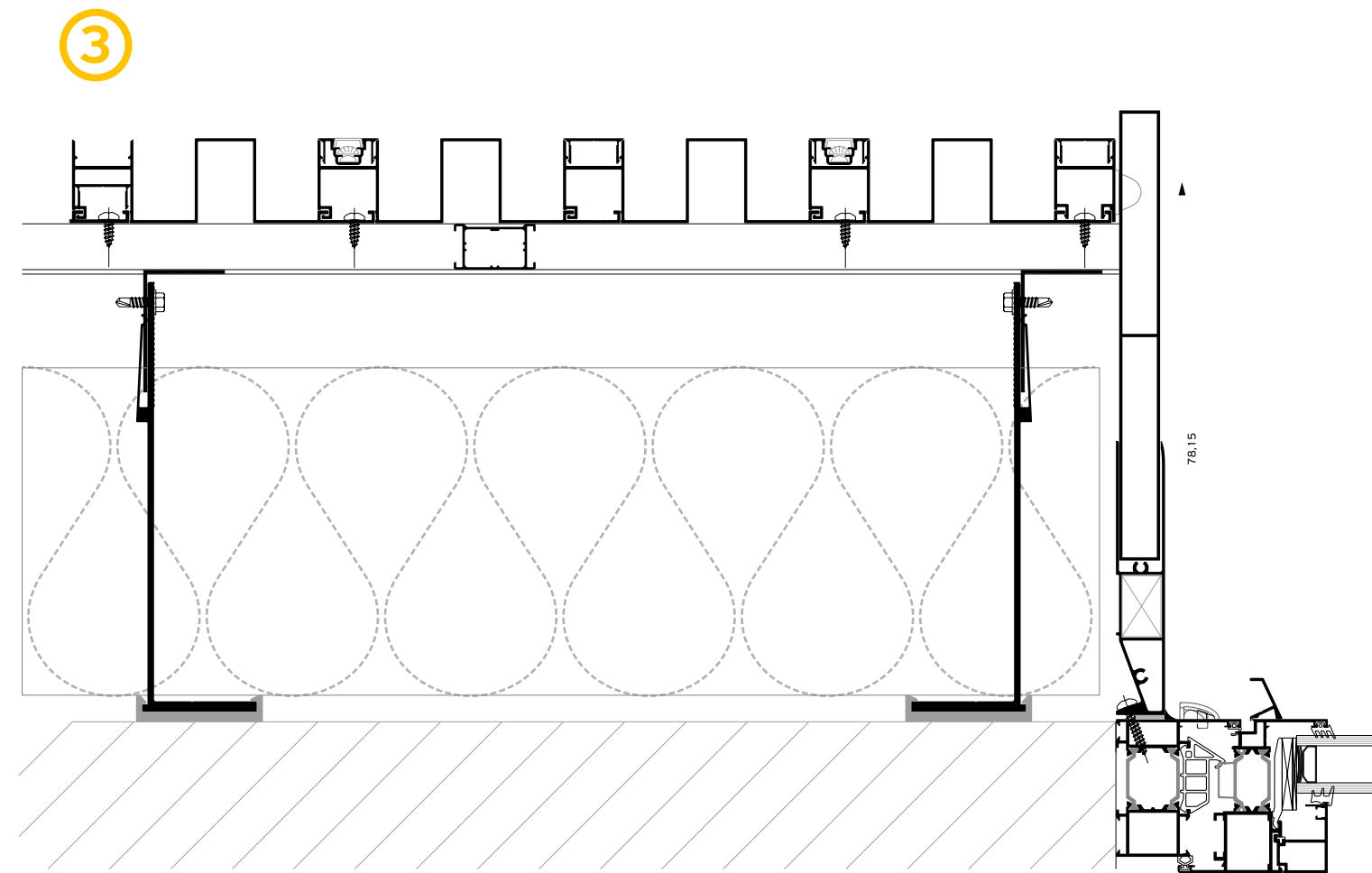
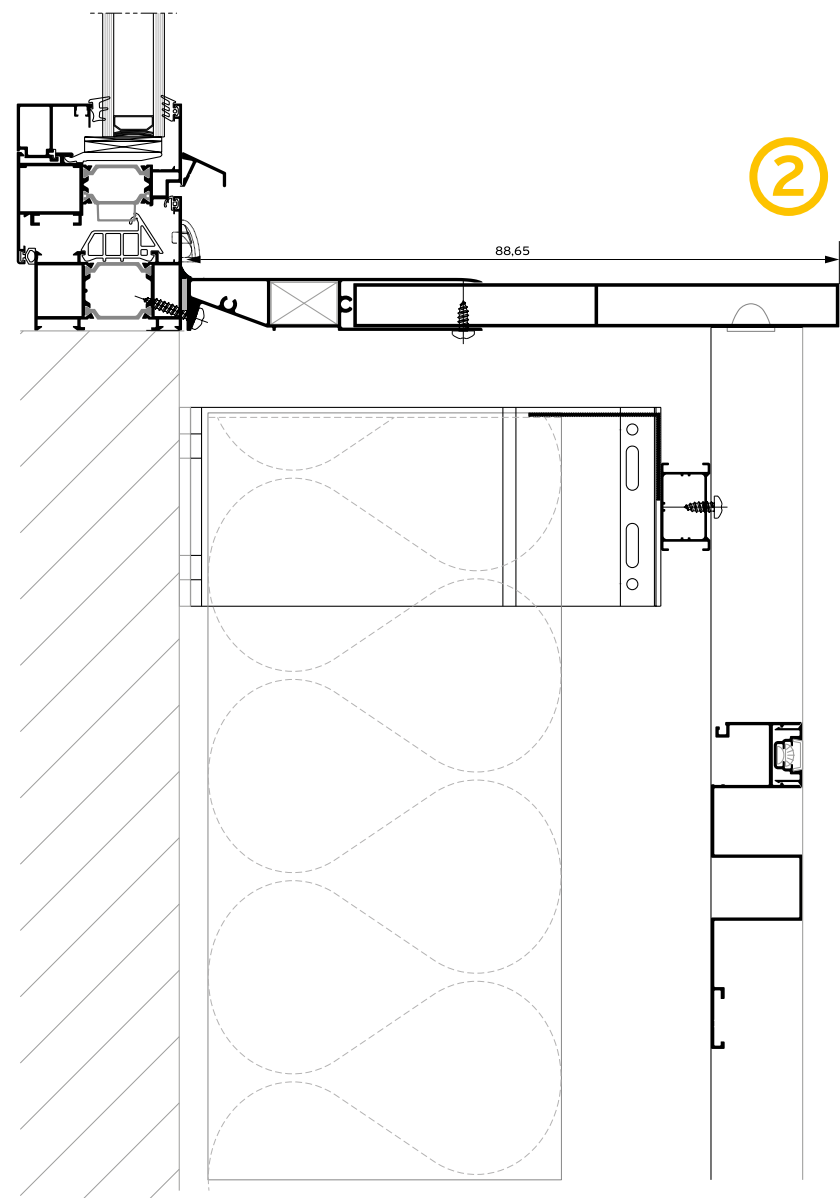
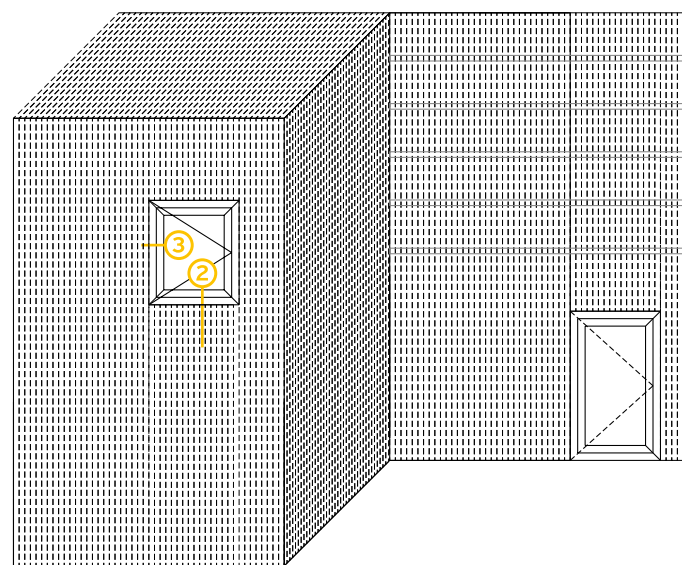

Alumil SMARTIA
Barcode Cladding

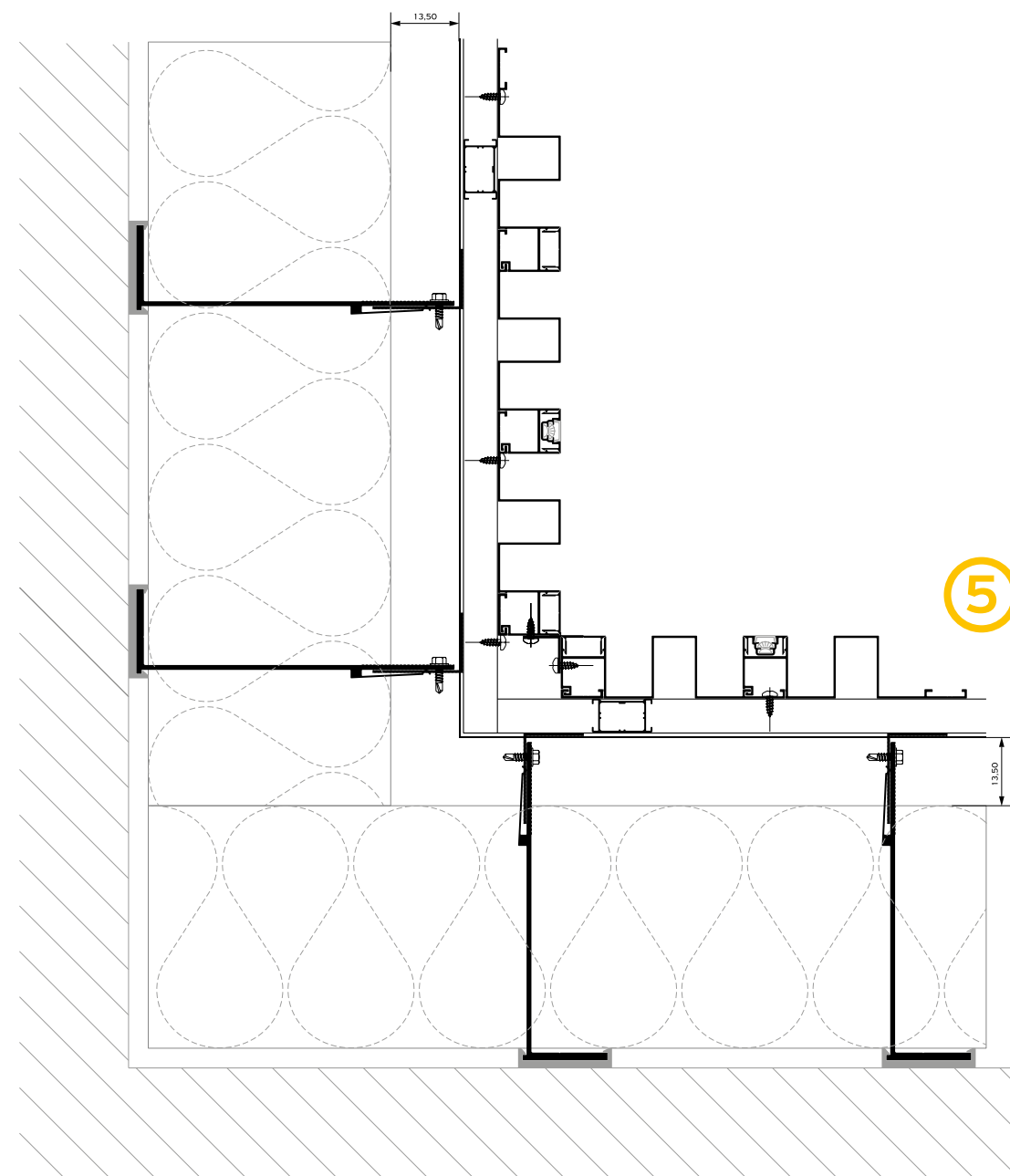
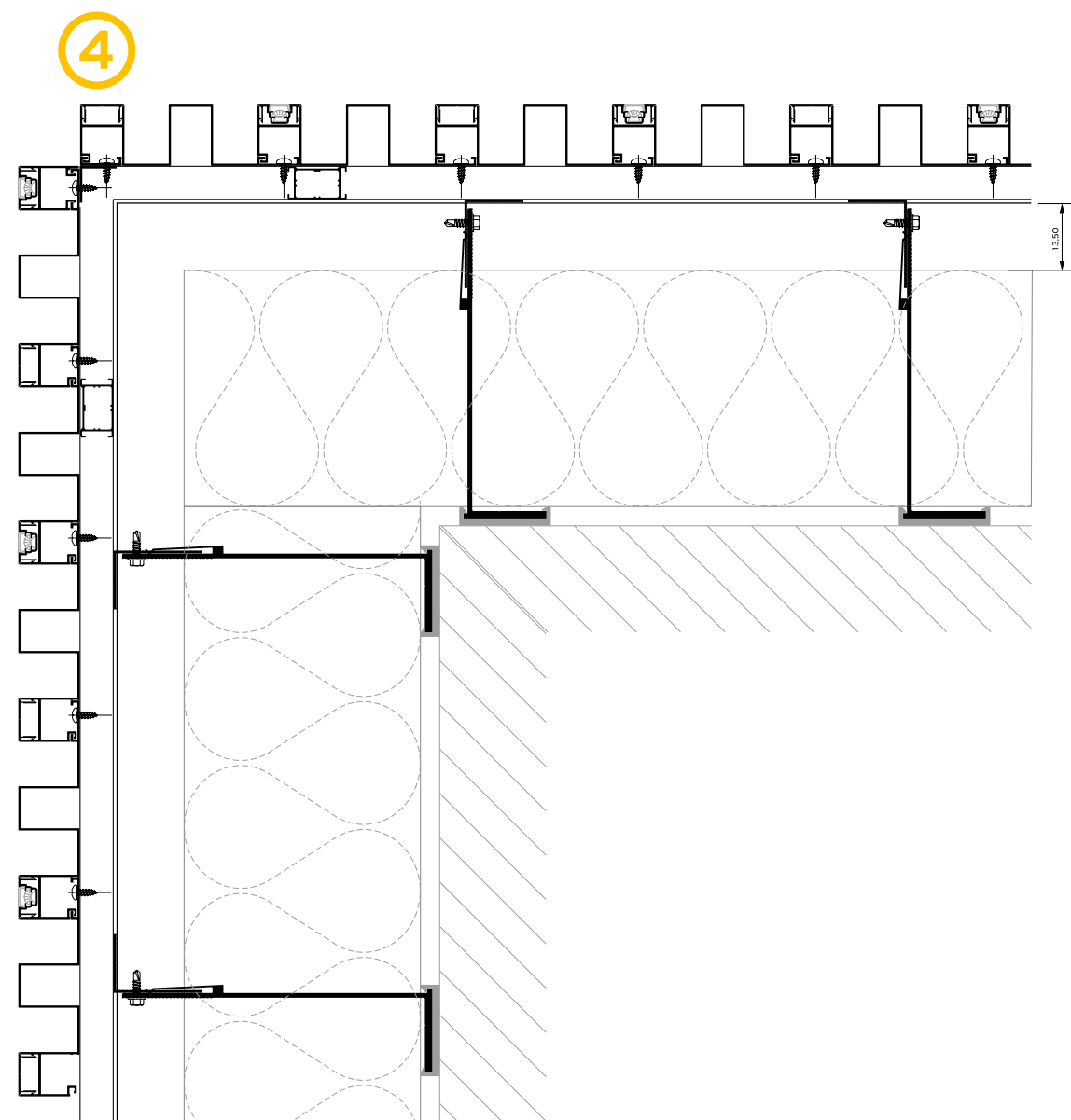
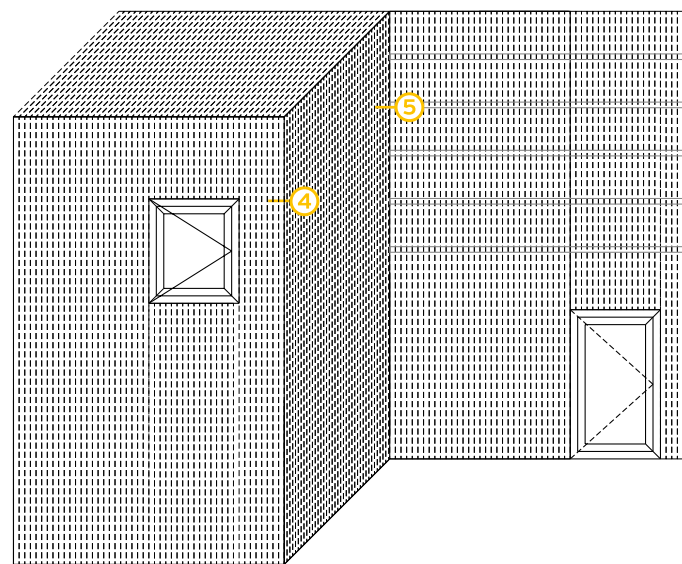

Alumil SMARTIA
Barcode Cladding

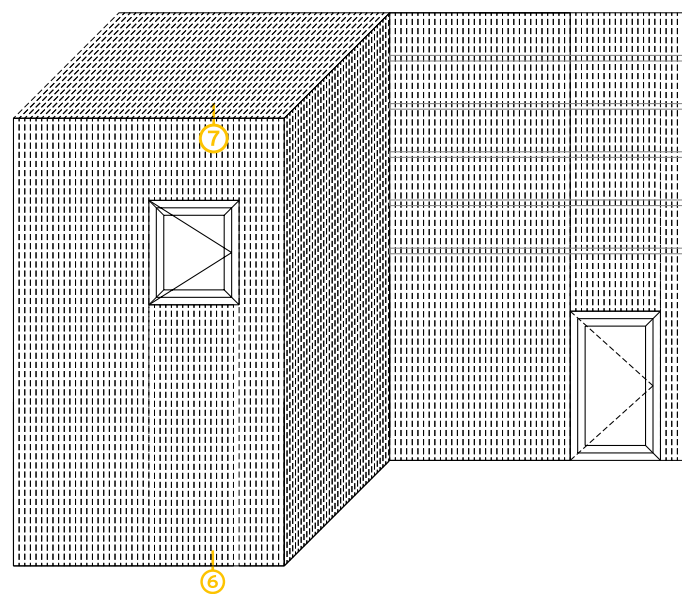

6

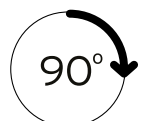
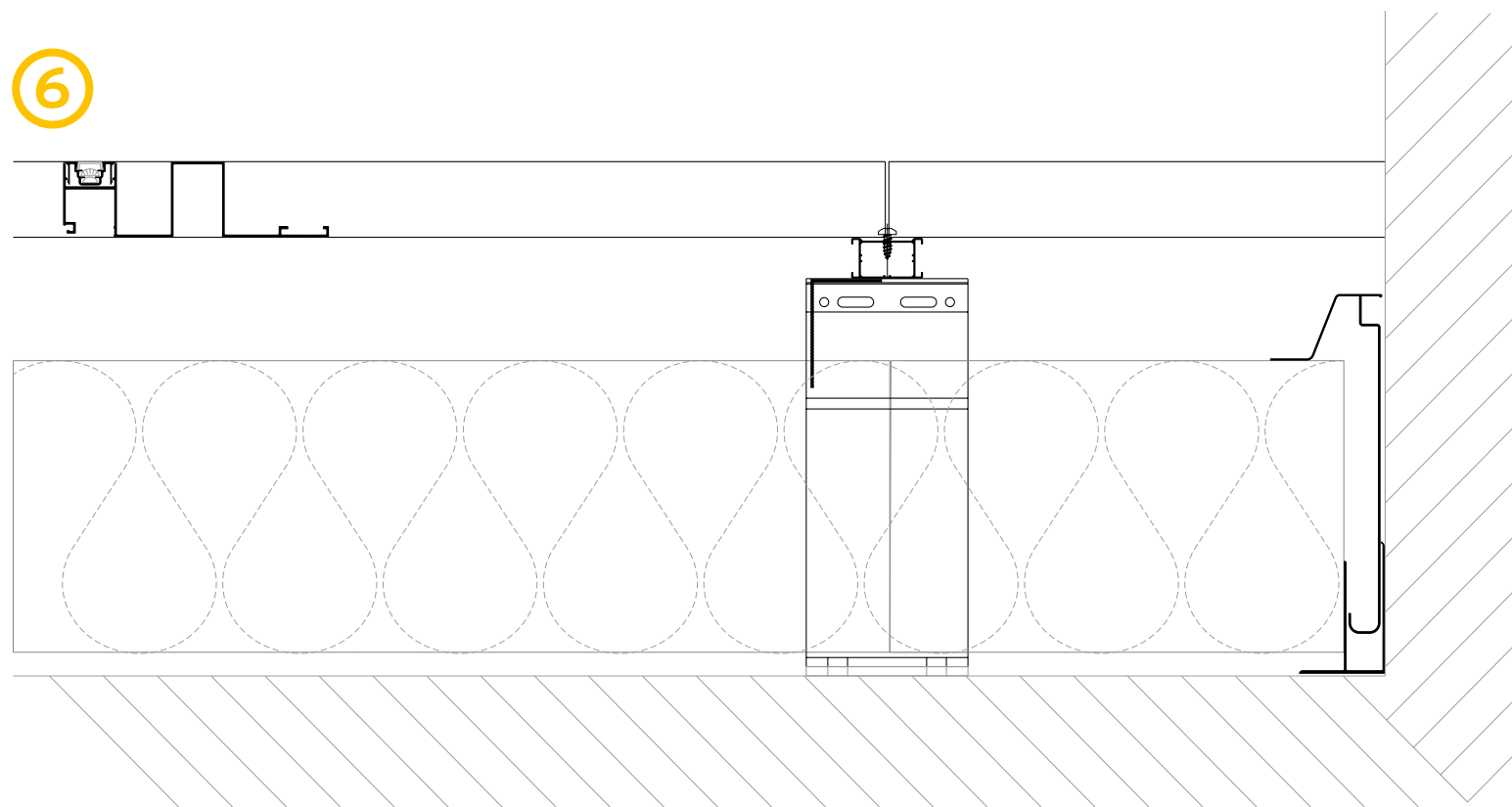

Rotate the technical drawing
90° CLOCKWISE IN ORDER
TO READ IT PROPERLY

7

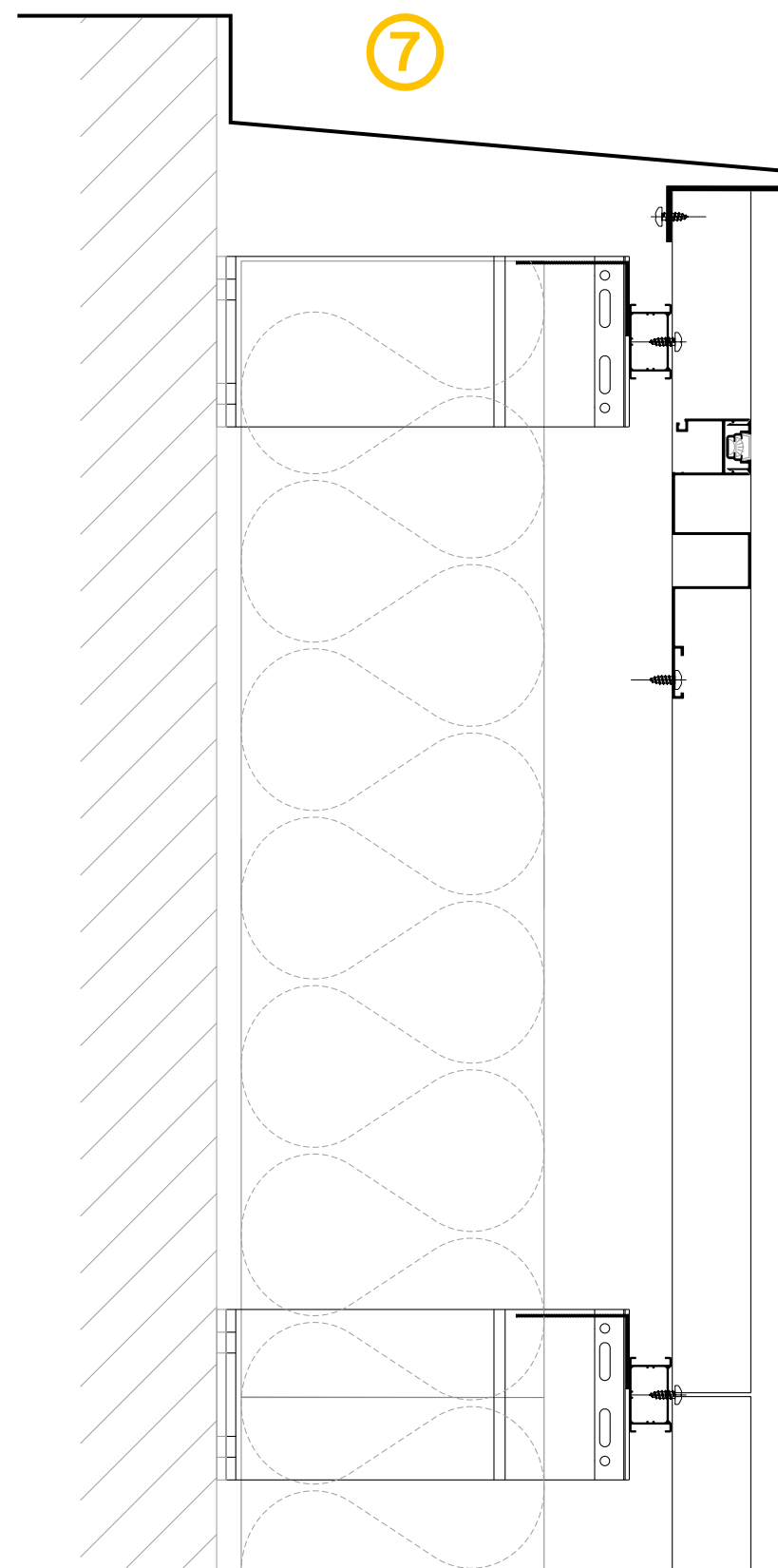

Alumil SMARTIA
Barcode Cladding

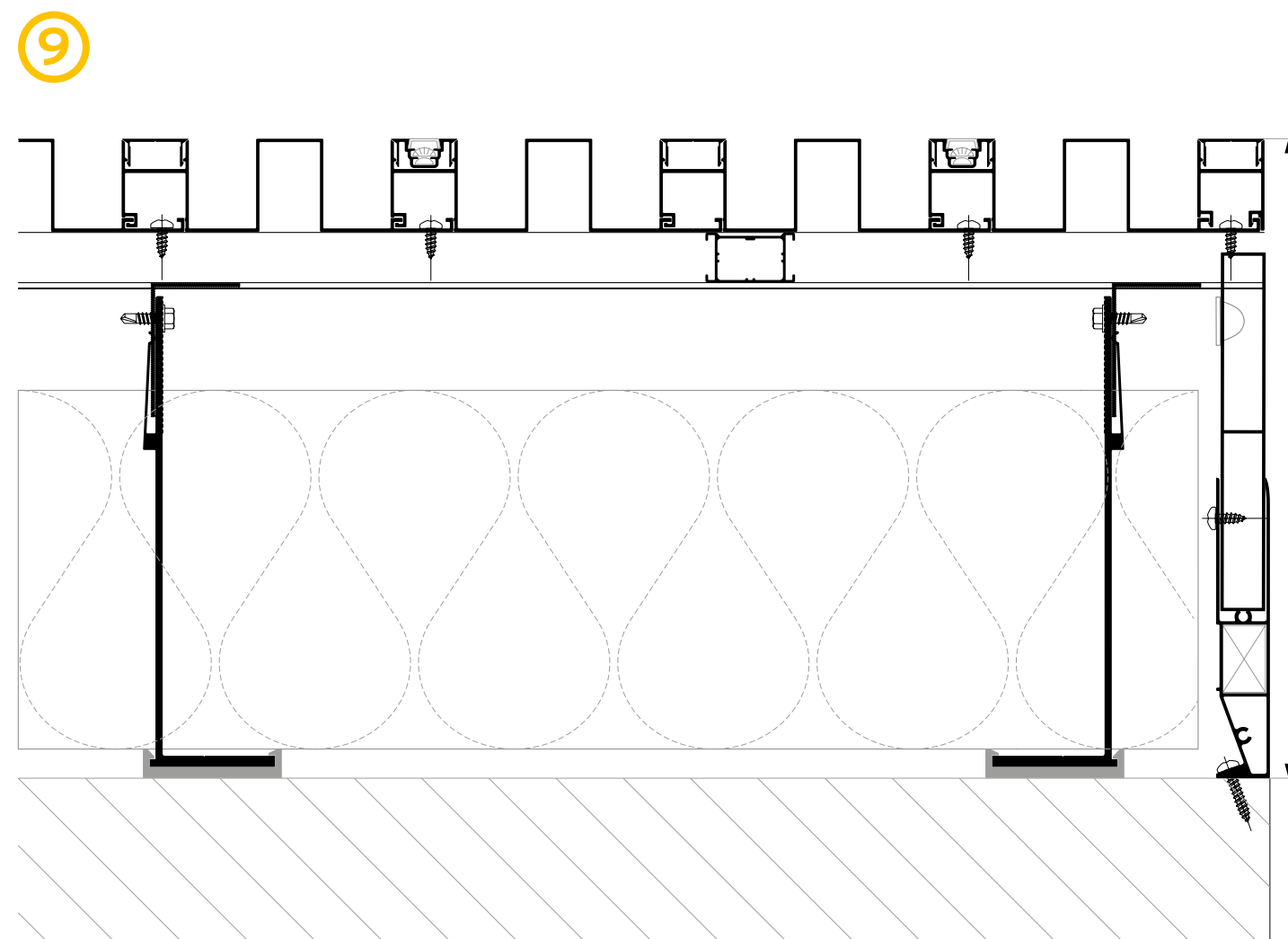
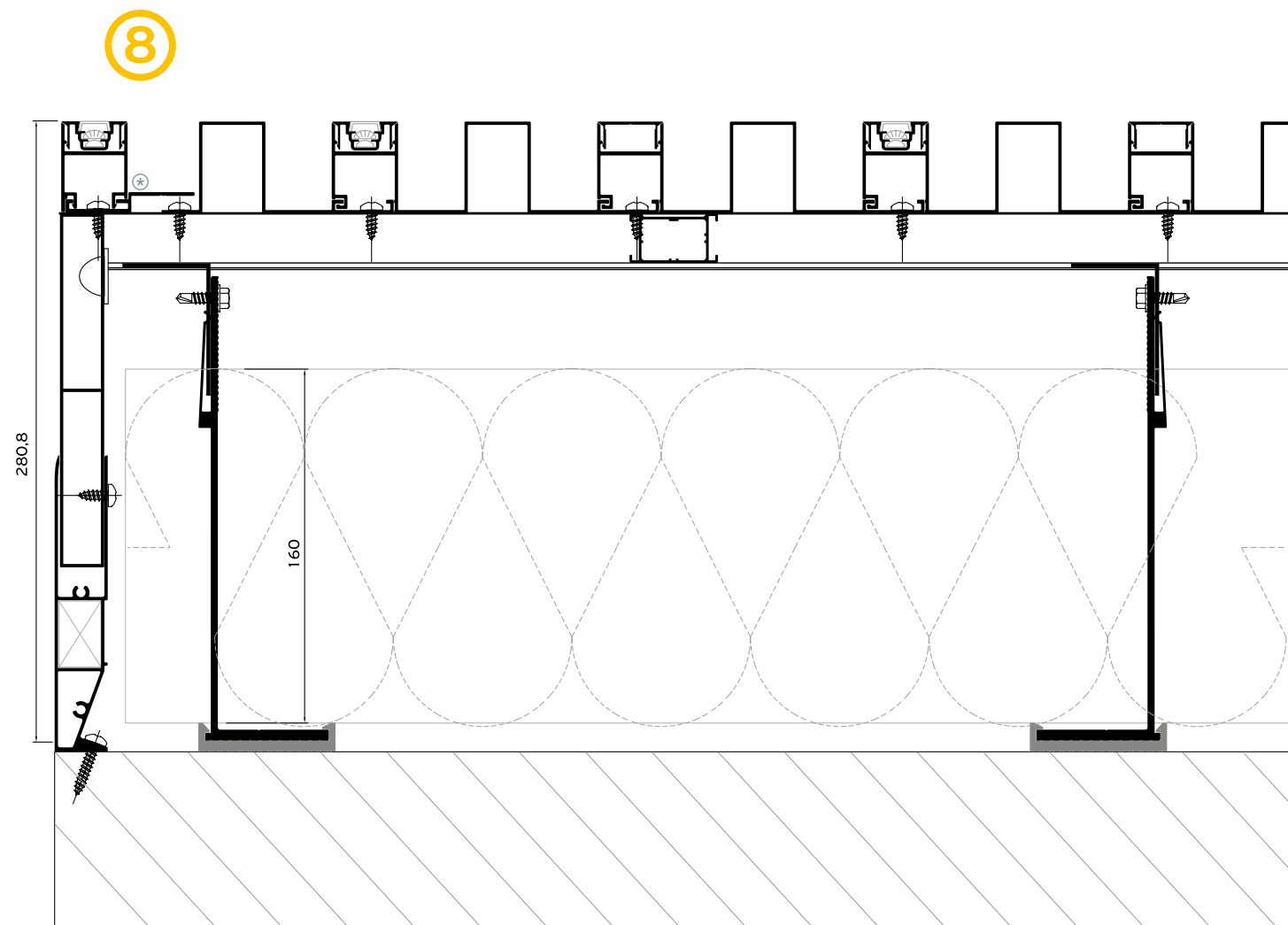
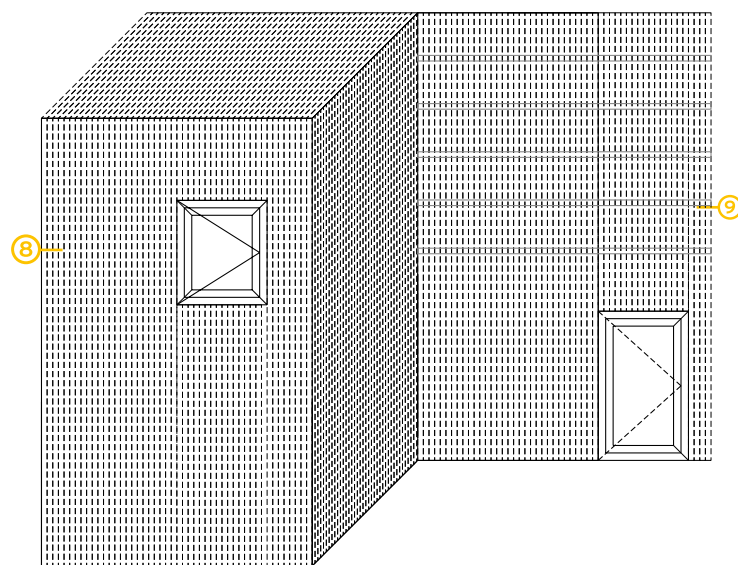

* Adjustment profile

Alumil SMARTIA
Barcode Cladding

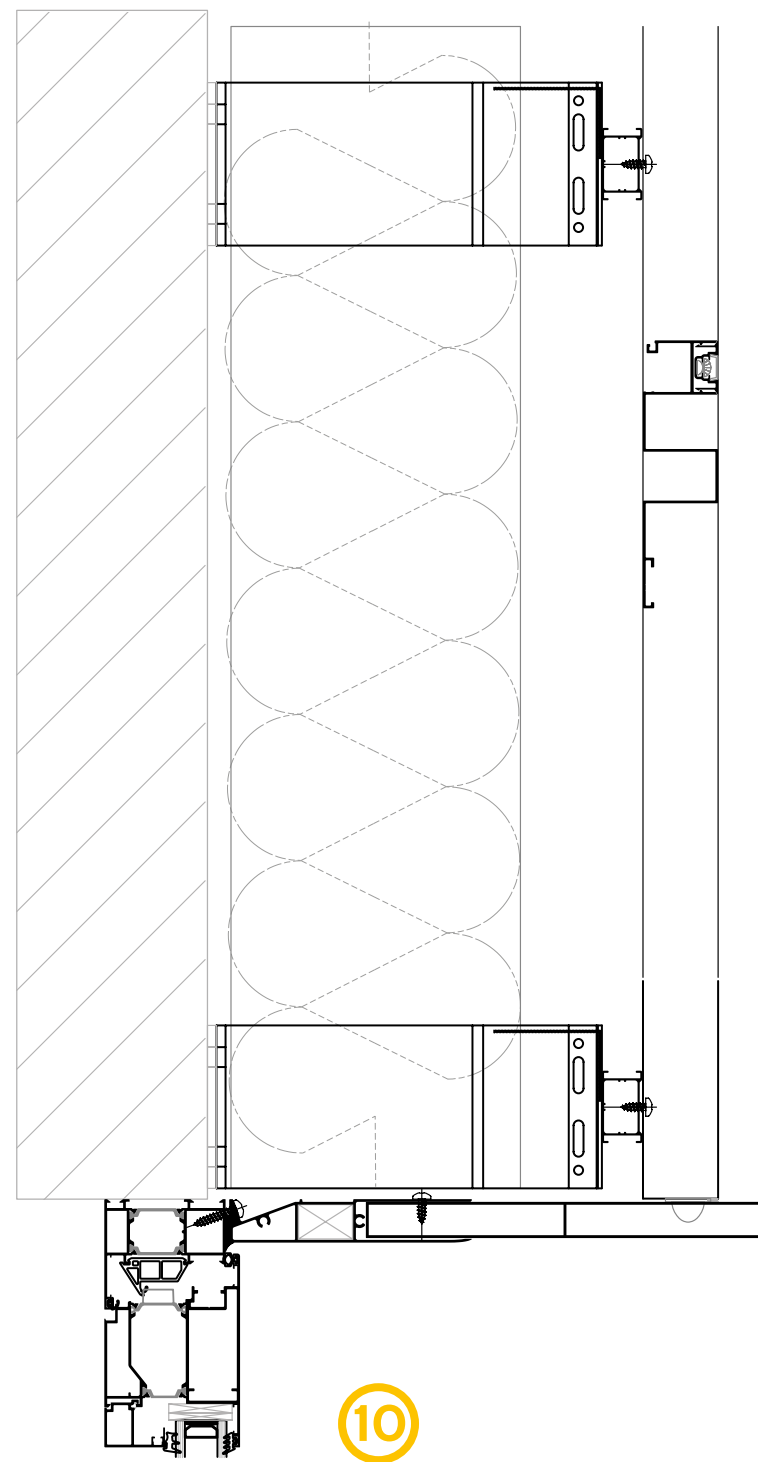
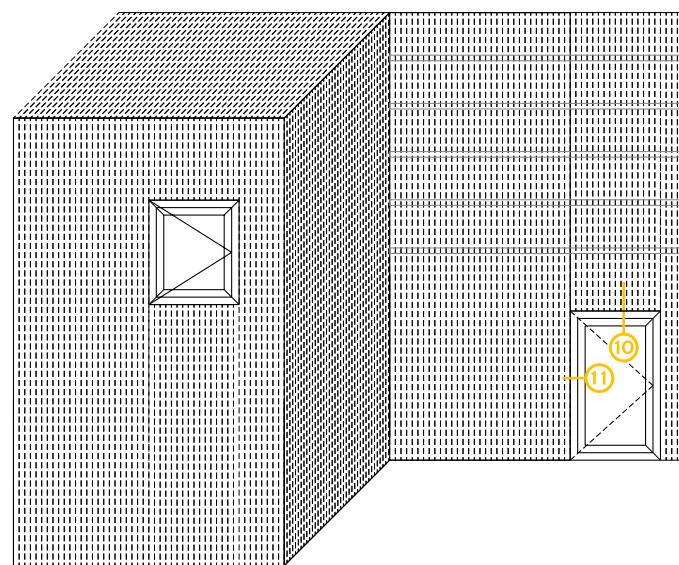

11

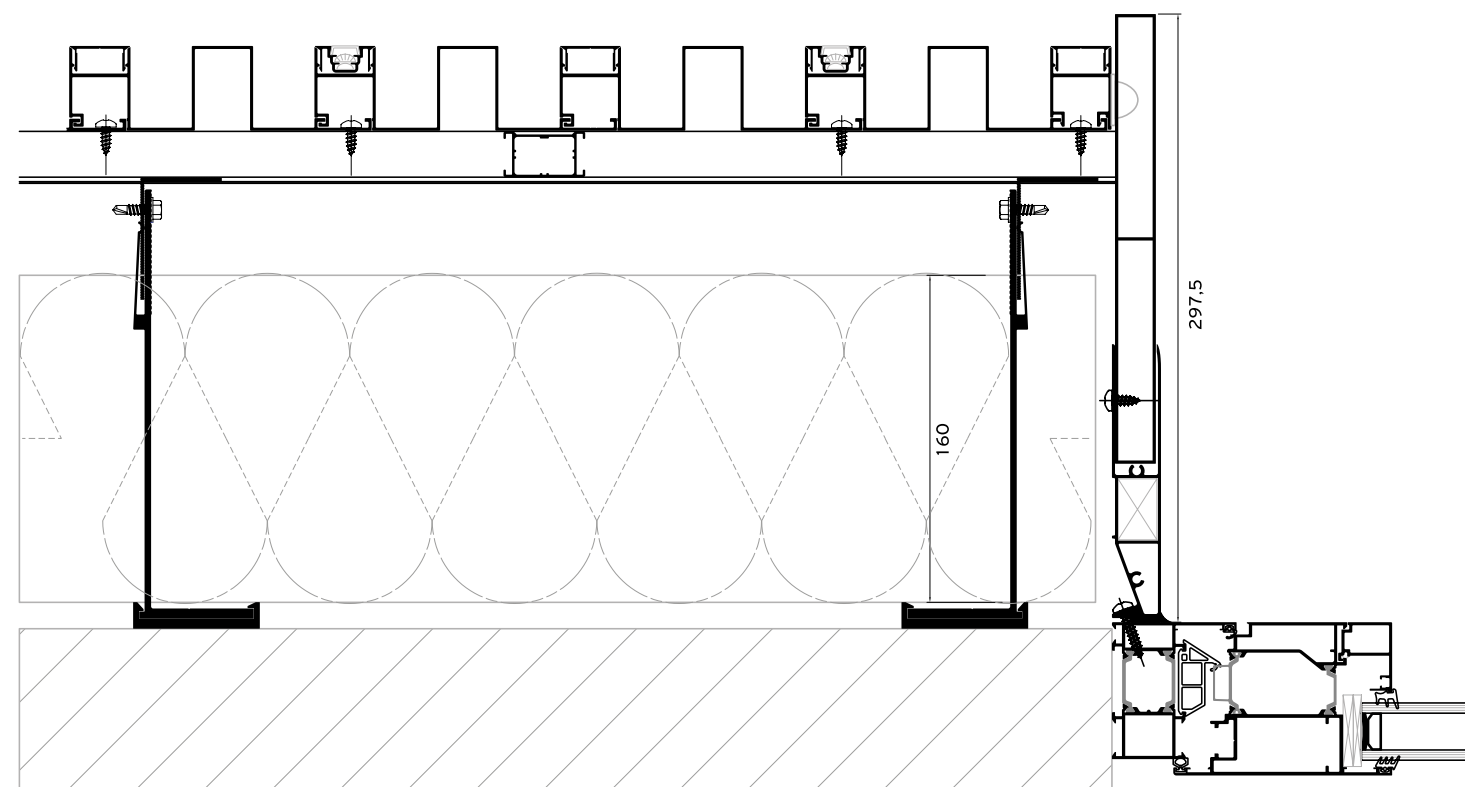

Alumil SMARTIA
Barcode Cladding

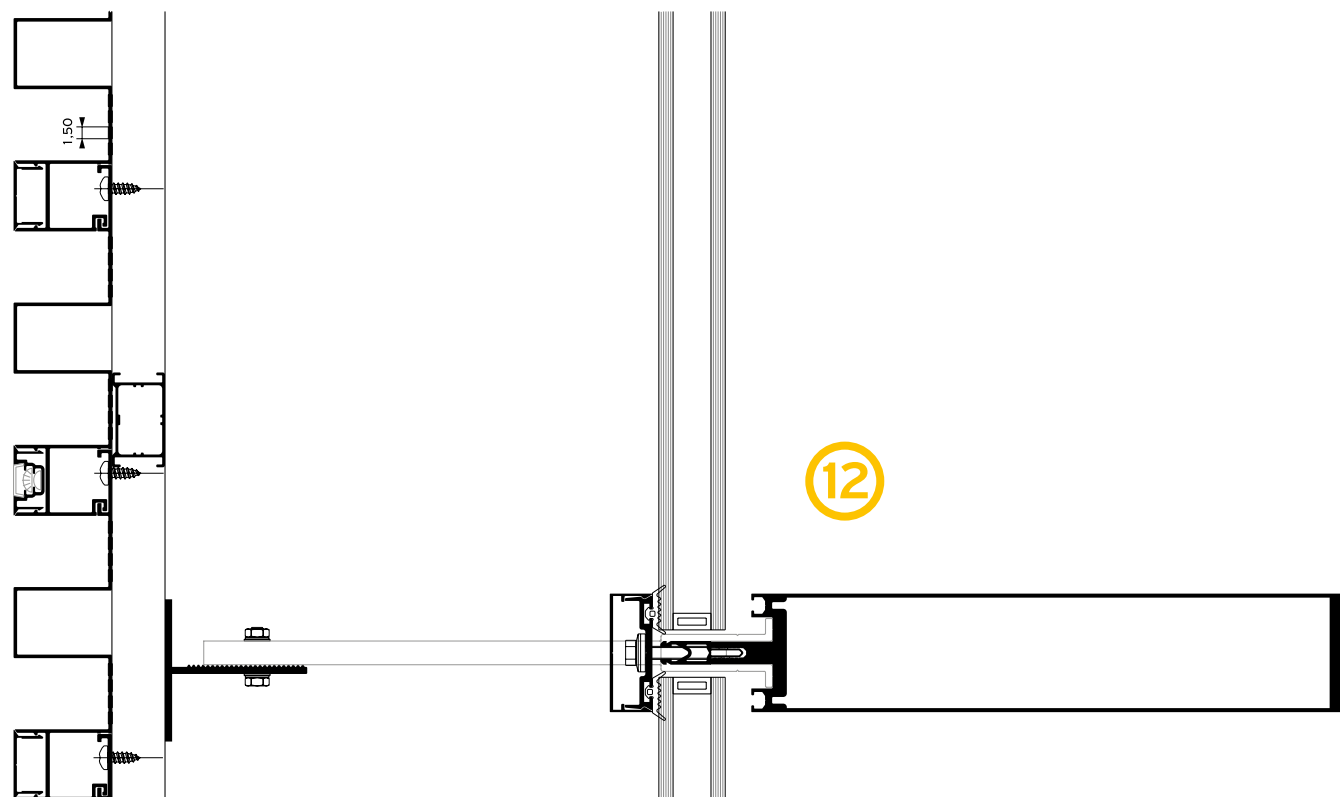
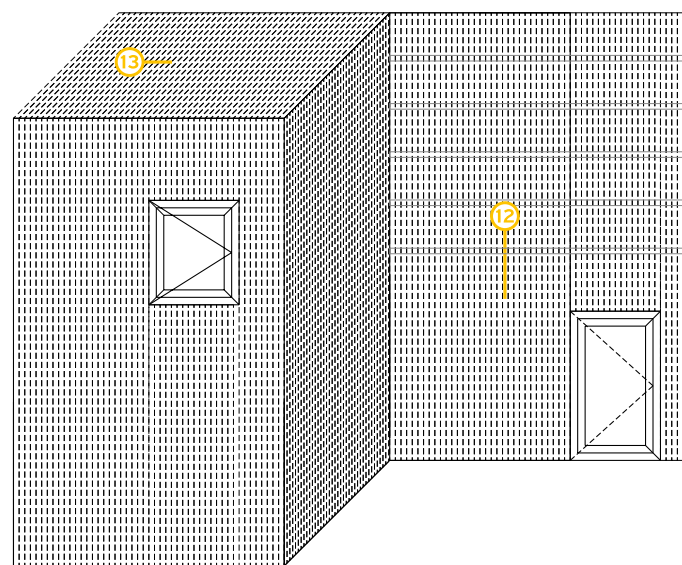

90°
Rotate the technical drawing
90° CLOCKWISE IN ORDER
TO READ IT PROPERLY

13

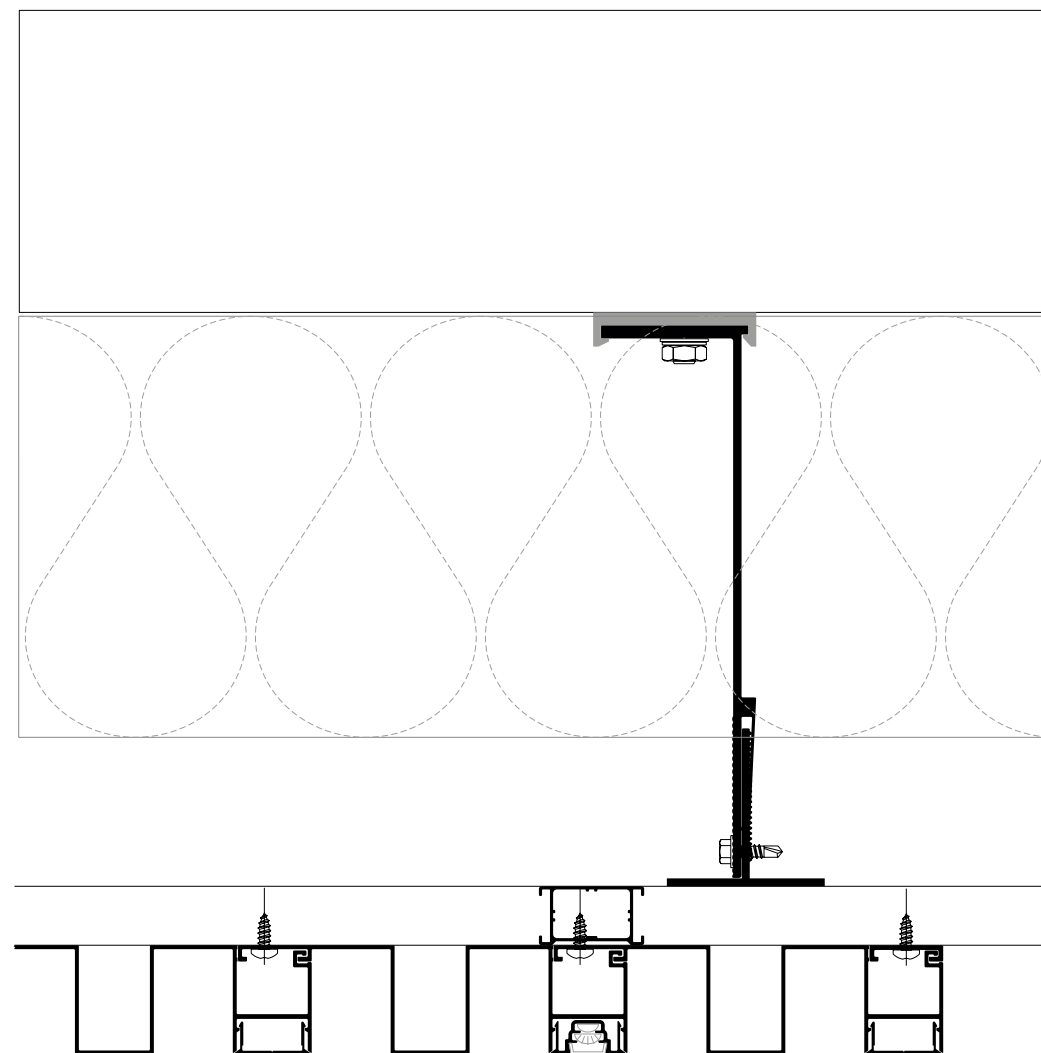

www.alumil.com

DISCOVER MORE:



**ALUMIL
HEAD OFFICES
& SHOWROOM - THESSALONIKI**

GOGOUSI 8, EFKARPIA
THESSALONIKI - GR 56429
TEL.: +30 2313011000
FAX.: +30 231692473
E-MAIL.: info@alumil.com

**ALUMIL
HEADQUARTERS**

KILKIS INDUSTRIAL AREA
KILKIS - GR 61100
TEL.: +30 23410 79300
E-MAIL.: info@alumil.com



**ALUMIL
HEAD OFFICES
& SHOWROOM - THESSALONIKI**

GOGOUSI 8, EFKARPIA
THESSALONIKI - GR 56429
TEL.: +30 2313011000
FAX.: +30 231692473
E-MAIL.: info@alumil.com

**ALUMIL
HEADQUARTERS**

KILKIS INDUSTRIAL AREA
KILKIS - GR 61100
TEL.: +30 23410 79300
E-MAIL.: info@alumil.com

www.alumil.com

alumil