



Alumil

Alumil  SMARTIA
M78

Contents



Introduction

SMARTIA M78 is a cost efficient unitized curtain wall, which combines minimal aesthetics with structural robustness.

Its Structural Silicone Glazing construction offers maximum transparency at the external surface of the façade.

Modular units, including glazing panes, are prefabricated in workshop conditions and this results in a fast and cost-effective installation with minimum manpower and tooling requirements.

This construction mode, renders M78 an ideal system for high rise buildings where meeting demanding deadlines is a prerequisite.

SMARTIA M78

WHEN AND WHY SELECT A UNITIZED CURTAIN WALL INSTEAD OF A STICK CURTAIN WALL	04
SYNOPSIS OF CHARACTERISTICS	06
SYSTEM'S FEATURES	08
INSTALLATION MODES	12
SECTIONS	14
APPLICATIONS	34
TABLE OF PERFORMANCE	35



When and why a Unitized Curtain wall should be selected instead of a Stick curtain wall

Key factors that make a Unitized Curtain Wall a one-way option in a project are:

SIZE OF THE FACADE		DEGREE OF REPETITION	
<p>More than 4000m²</p> <p>UNITIZED CW</p>	<p>Less than 4000m²</p> <p>STICK CW</p>	<p>High degree of repetition</p> <p>UNITIZED CW</p>	<p>Low degree of repetition</p> <p>STICK CW</p>
HEIGHT OF THE BUILDING		ALLOWANCE FOR STRUCTURAL MOVEMENT	
<p>More than 6 floors</p> <p>UNITIZED CW</p>	<p>Less than 6 floors</p> <p>STICK CW</p>	<p>Demand for dynamic test, buildings located in seismic area</p> <p>UNITIZED CW</p>	<p>Poor performance in seismic areas</p> <p>STICK CW</p>
INSTALLATION MANPOWER		SPACE SITE	
<p>Minimizes installation manpower</p> <p>UNITIZED CW</p>	<p>Requires significant manpower</p> <p>STICK CW</p>	<p>Ideal for limited space site</p> <p>UNITIZED CW</p>	<p>Requires lot of space site for construction</p> <p>STICK CW</p>

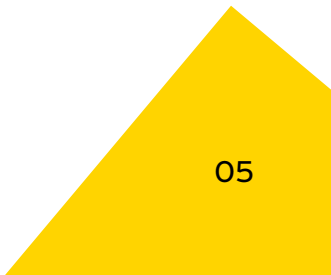

Synopsis of Characteristics

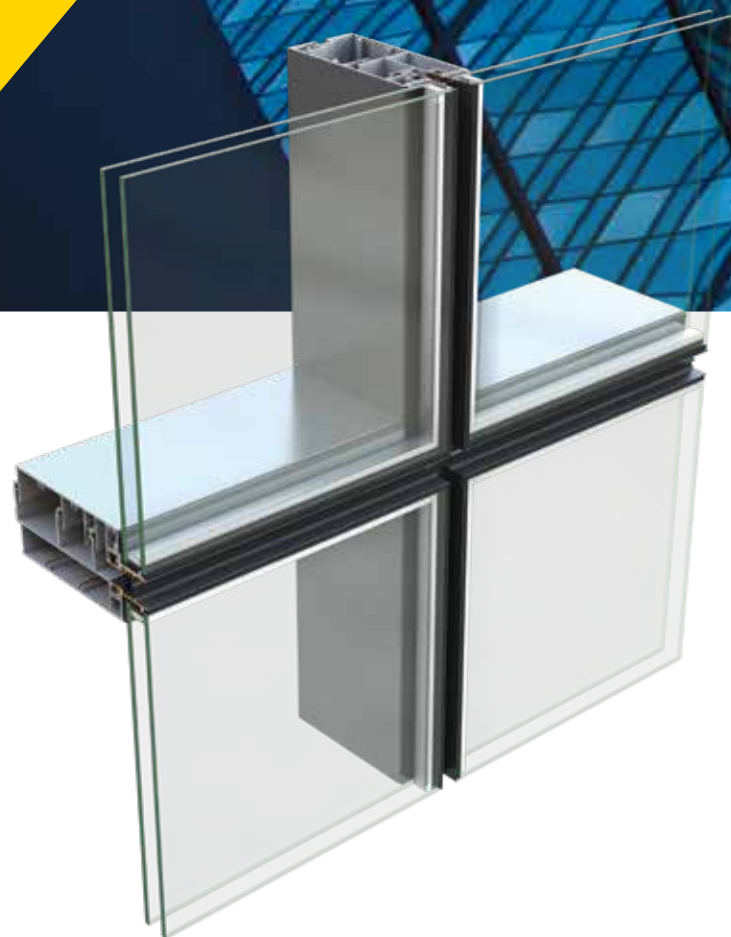

SMARTIA M78 is a unitized curtain wall system which offers a unique aesthetic effect, thanks to its structural silicone glazing that provides a top-quality finished product.

- / Basic system width **78mm**.
- / Structurally bonded glazing, providing a flush exterior appearance.
- / Various hinged typologies can be implemented: projected, parallel projected and all and turn windows.
- / horizontal unit joint **12mm**.
- / vertical unit joint **19mm**.
- / stack joint height **92mm**.
- / 3 levels of sealing.
- / Concealed drainage.
- / Certified performances by IFT.
- / Glazing from 24 up to 46mm.

Technical characteristics

Visible	78mm
Mullion depth	160mm
Transom width	160mm
Mullion moments of Inertia	$I_x=643\text{cm}^4$, $I_y=46\text{cm}^4$
Transom moments of Inertia	$I_x=161\text{cm}^4$ $I_y=568\text{cm}^4$
Maximum dimensions WxH	1500x3500 mm

System's Features



Design Aesthetics

By using Structural Silicone Glazing, a continuous glass appearance is given to the external surface of the façade, providing an unobstructed view, and maximizing the natural light in the interior.

Furthermore, sightlines of 78mm width and 160mm depth, render M78 ideal for buildings with transparency and minimal interior appearance requirements.

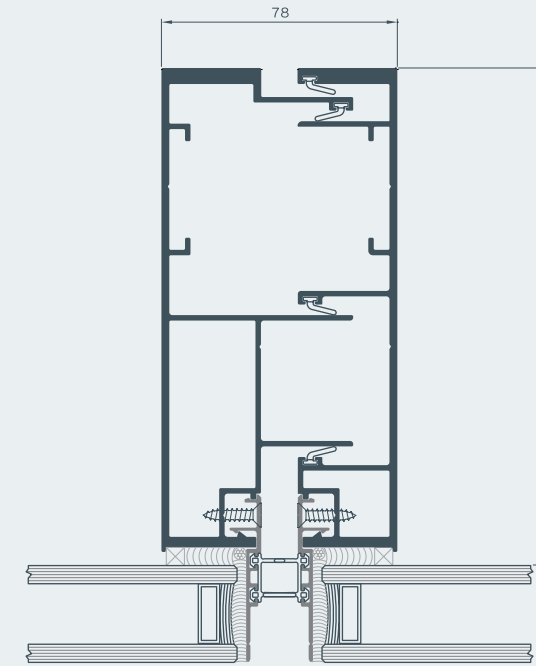

Ease of fabrication

The assembly of profiles is completed by 90 degrees connection, increasing production speed with no need of any additional accessories and equipment. Since fabrication procedure is very simple, no skilled manpower is required.

Finally, the connections are sealed with silicone – and they could easily "re-seal" at any time of production or afterwards.



Typologies and special solutions

The system provides a wide range of typologies and special solutions. Apart from fixed units, the system also offers solutions that include units with opening element such as projected windows, parallel projected windows, and hinged windows. Furthermore, corner constructions can be easily done, as well as integration of aluminium louvres in front of the façade.

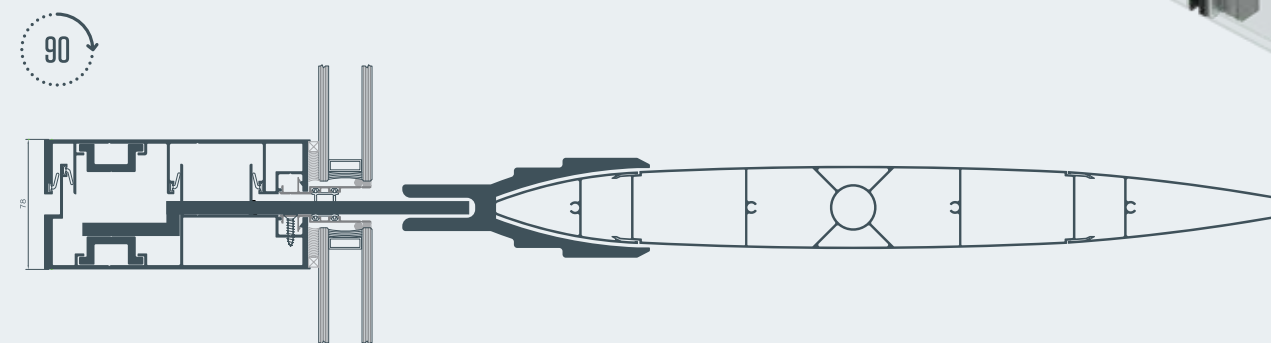

Customization

M78 design philosophy allows customized solutions when the specifications of a project require it. System's versatility from static sufficiency to the possibility of integrating a sliding system, highlights the advanced features of M78, that make it an ideal choice even for the most demanding projects.

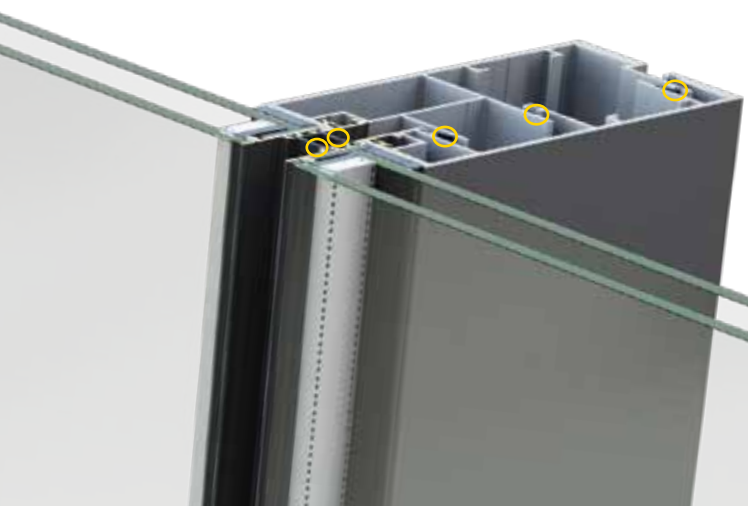
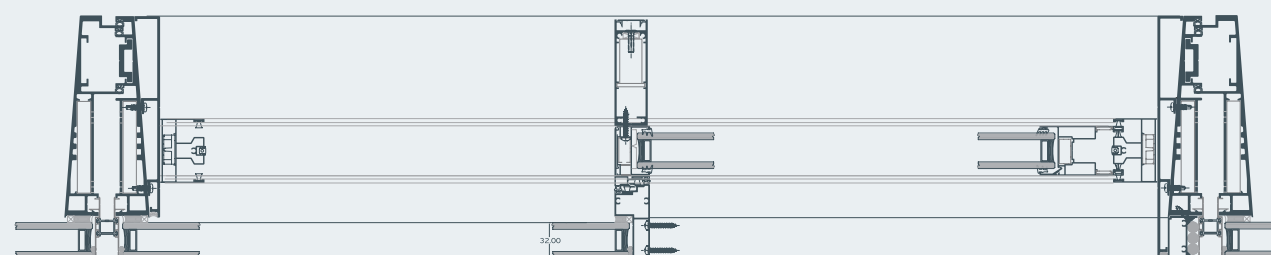
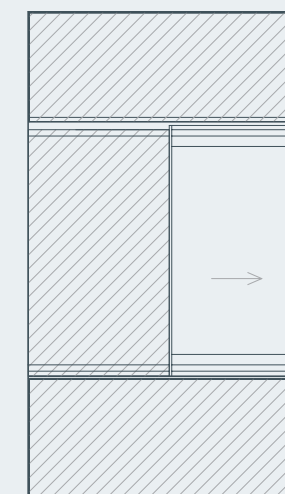
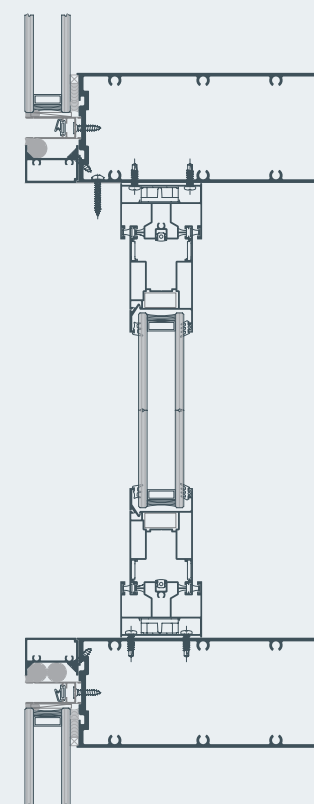

Sealing technology

M78 offers a three-chamber sealing - using five gaskets - that reinforce the system and help it to remain practically unaffected by heavy weather conditions.

Installation modes



Considering that modules are totally prefabricated in factory, the only process that is conducted on site is the installation. This is very convenient in the case of space site limitations and when scaffolding is not an option. During the installation, cranes are needed, in order to post the modules in the building envelope and with the use of brackets, these modules are fixed on building slabs.

Brackets are designed following the parameters below:

- / Transfer the reaction from the unitized panels to the building main structure.
- / Accommodate building movement.

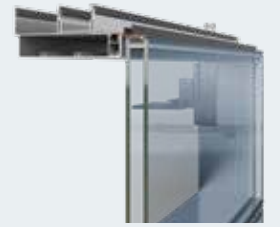

There are three different versions of installation, depending on each project

/ The module is posted on slab, transom is needed

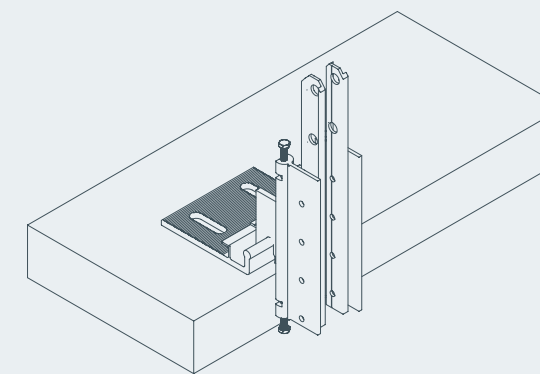

/ The module is posted on slab, no transom is needed

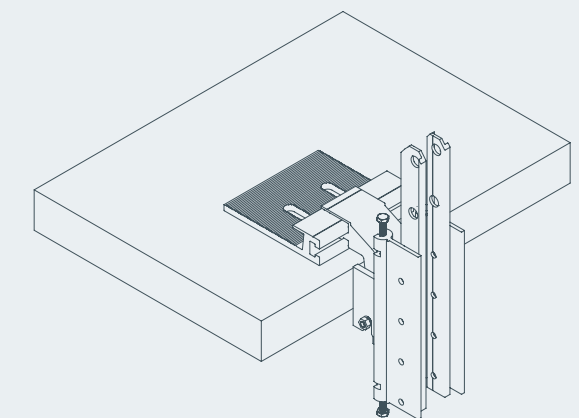

/ The module is posted on column

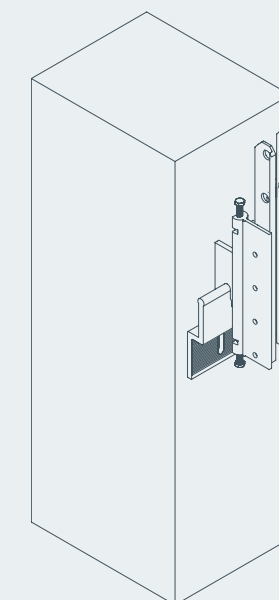

Sections

01

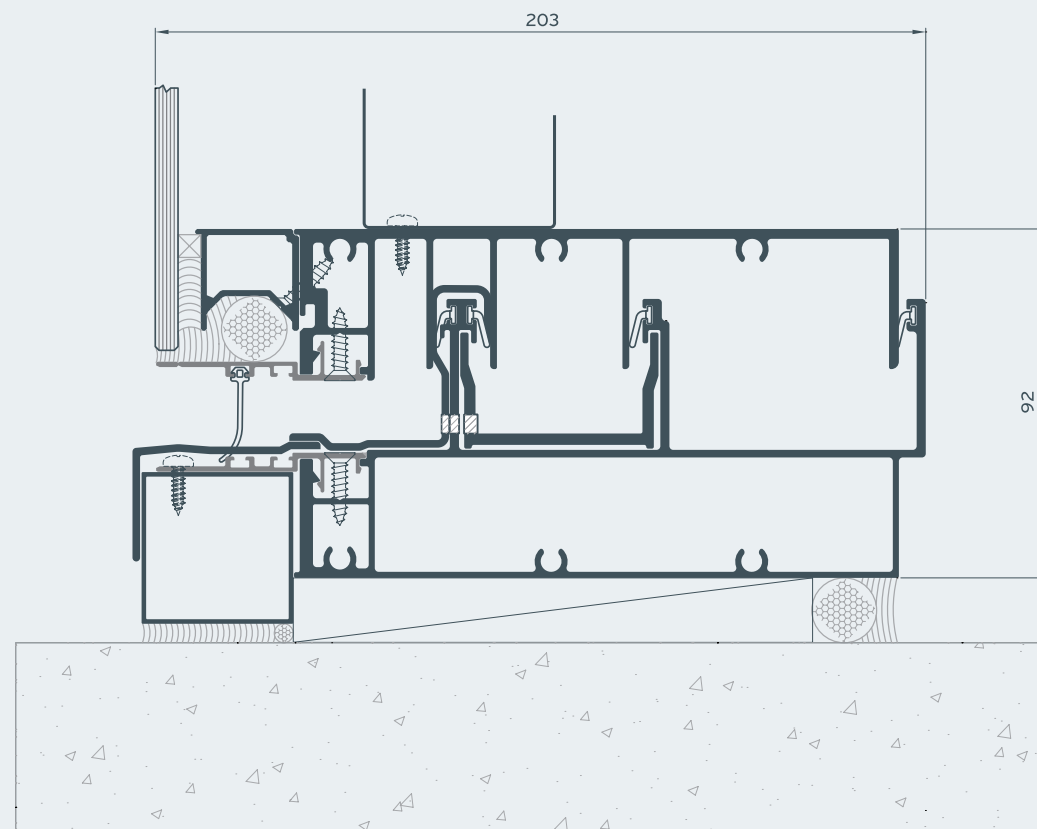
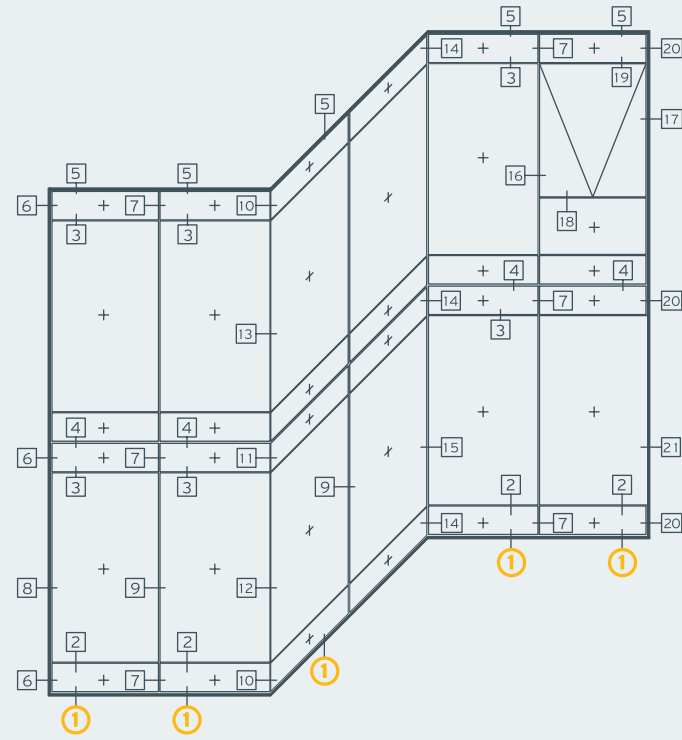

02

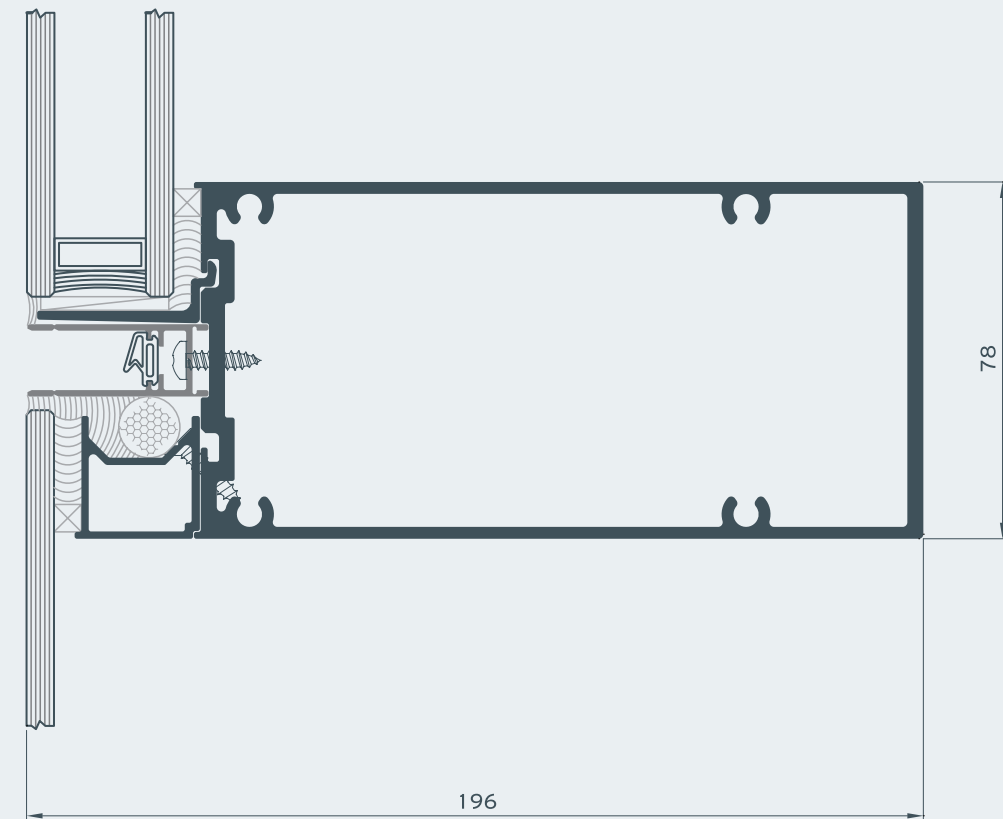
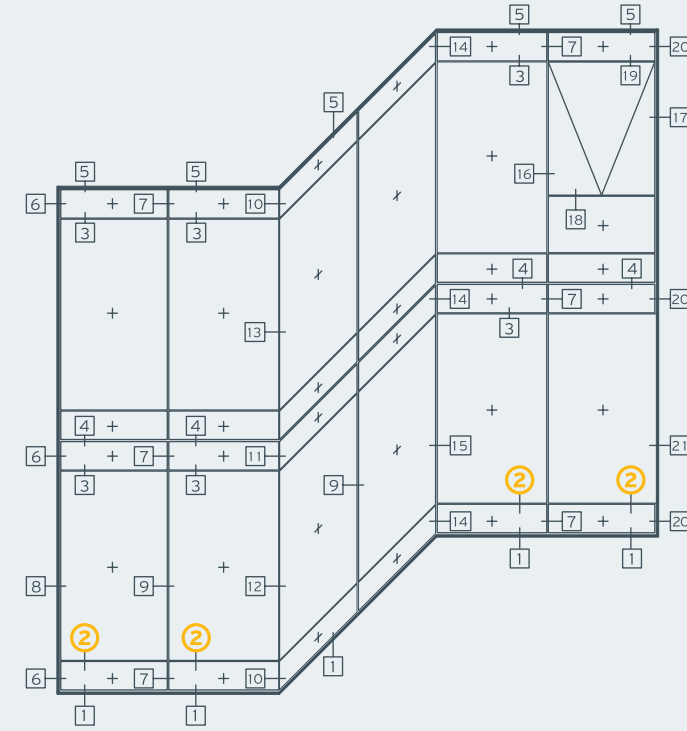

03

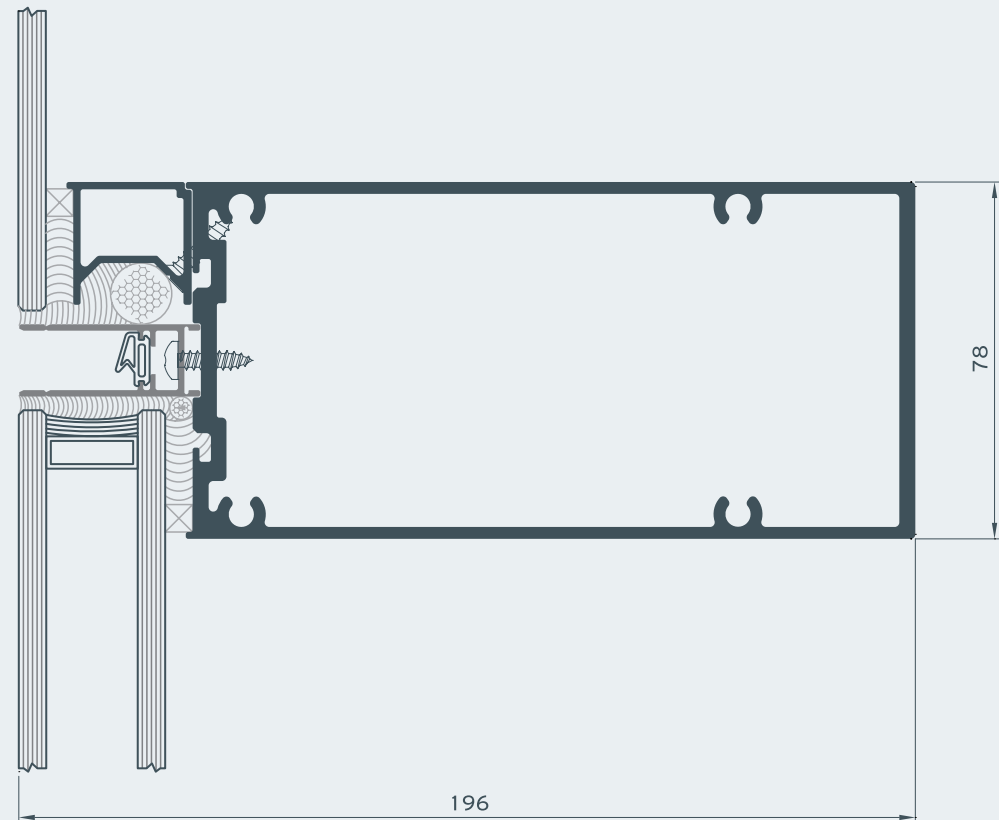
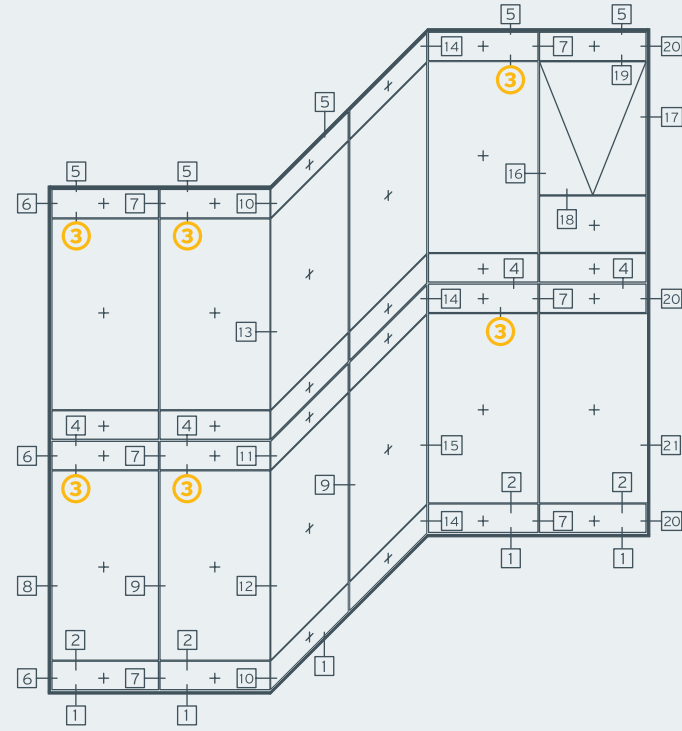

04

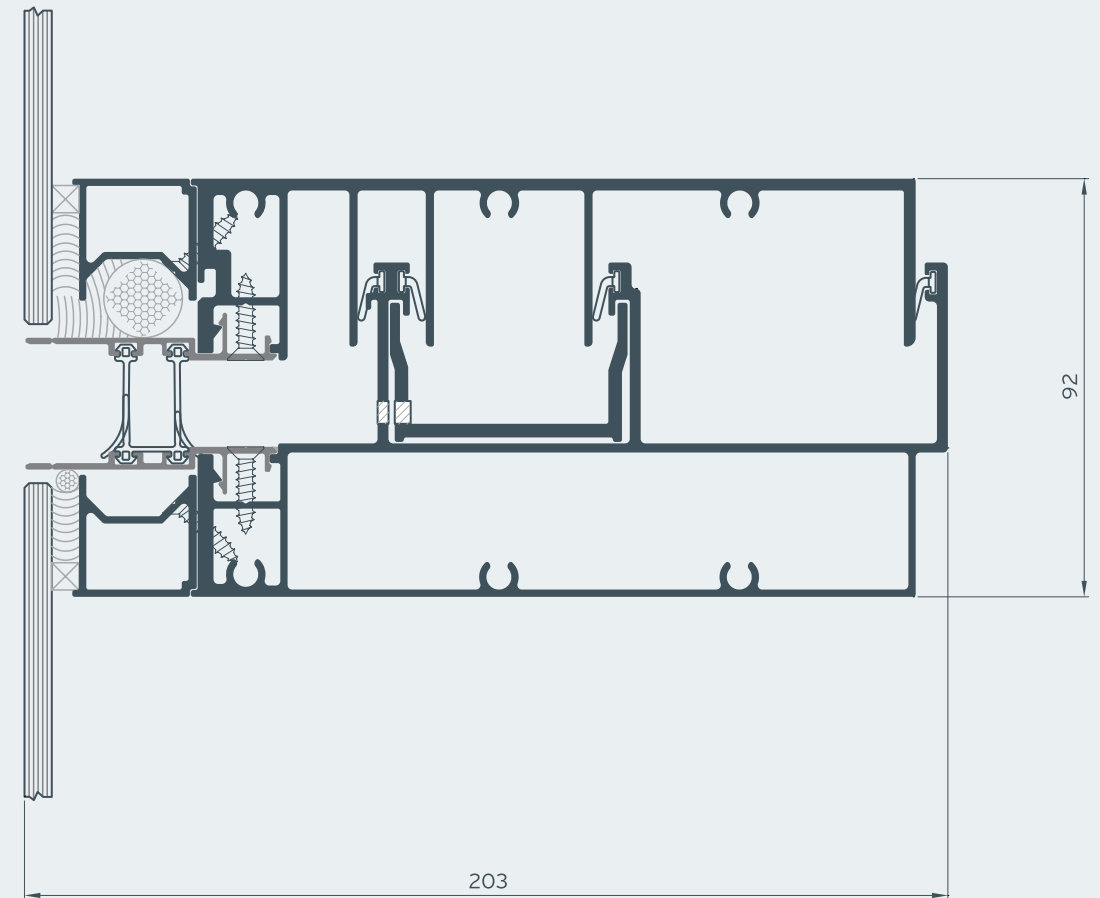
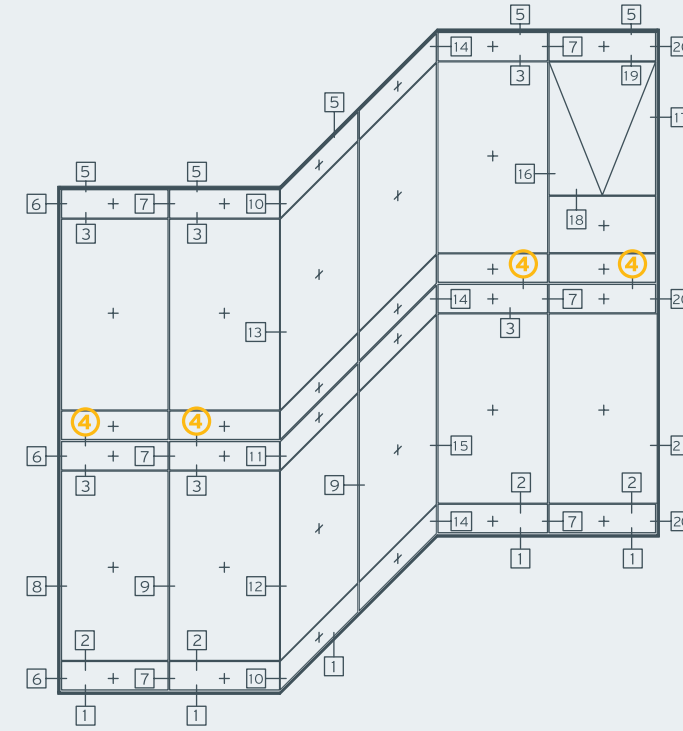

05

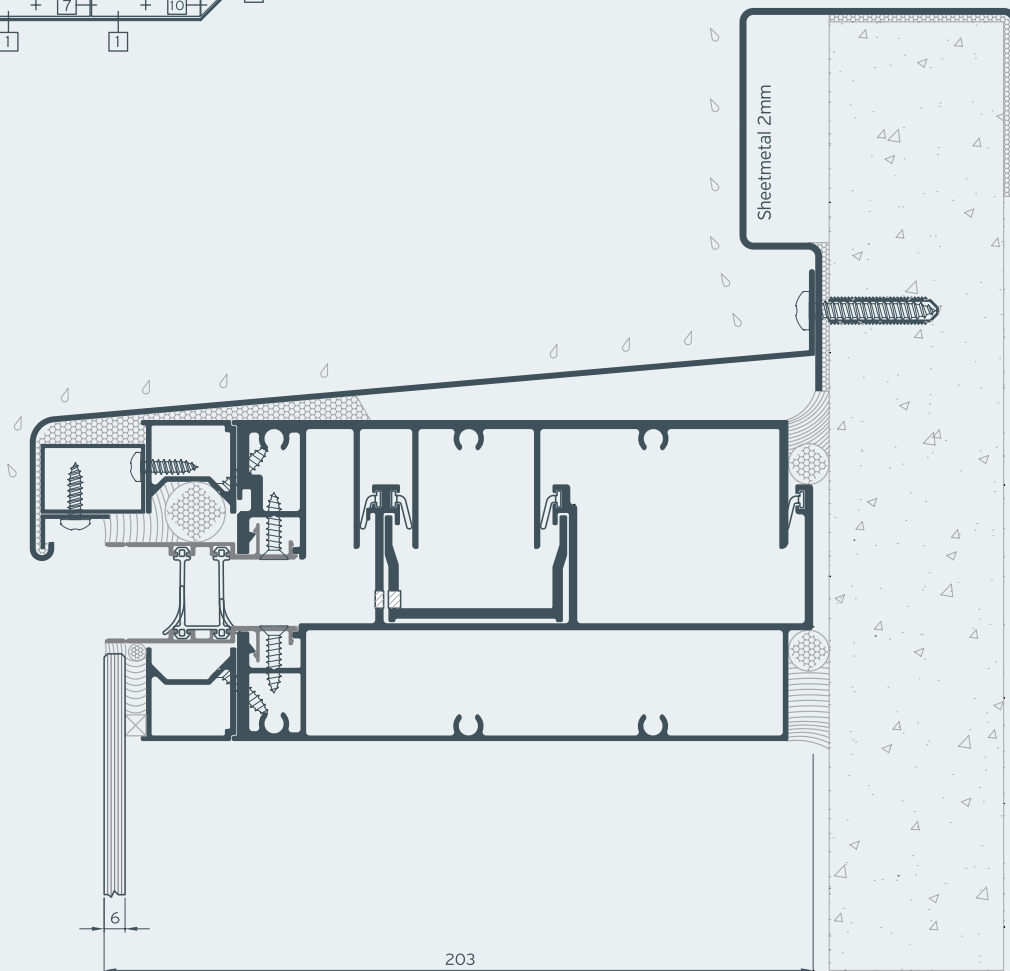
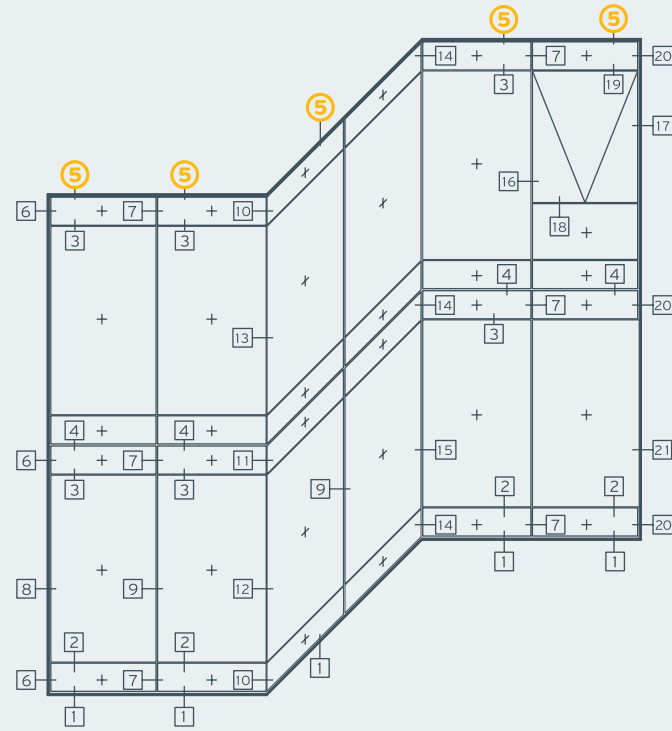

06

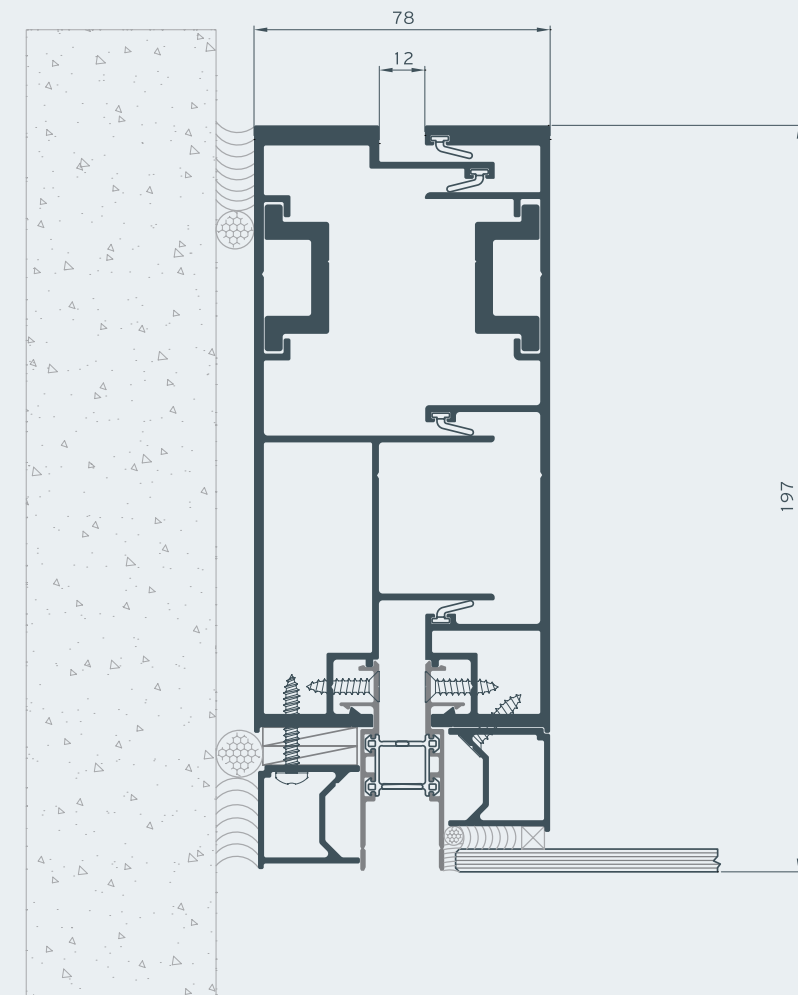
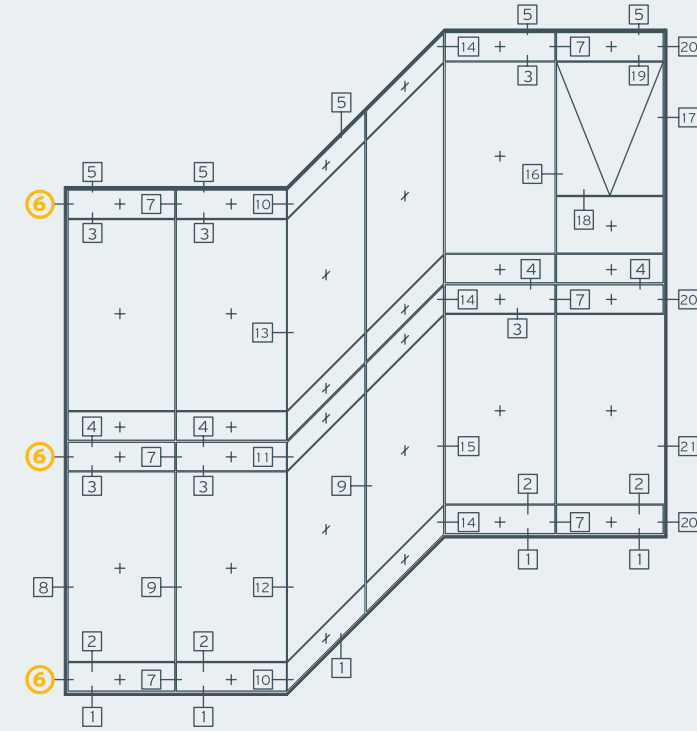

07

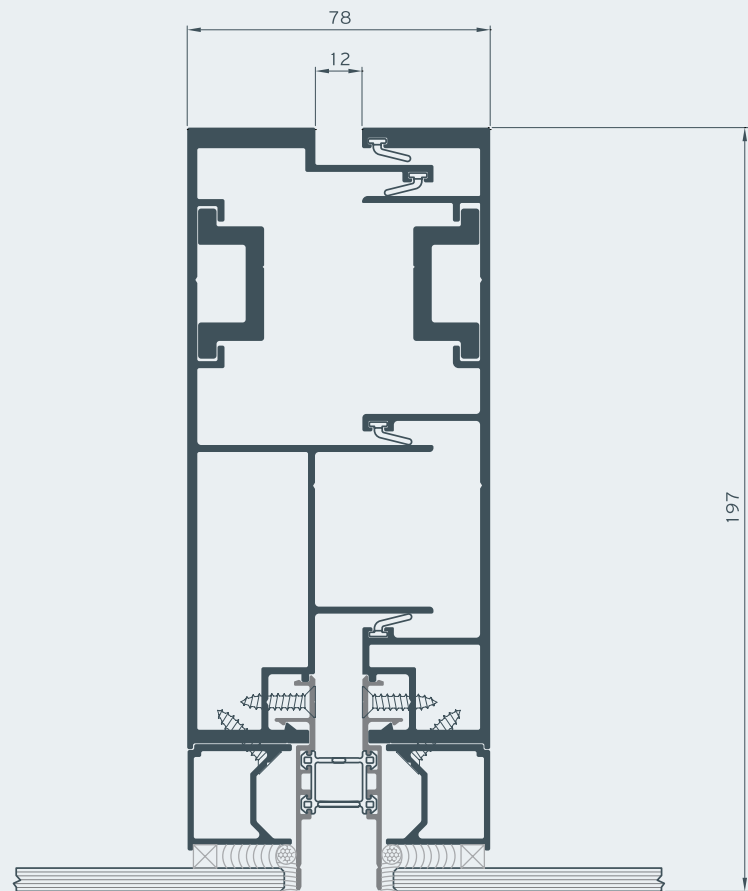
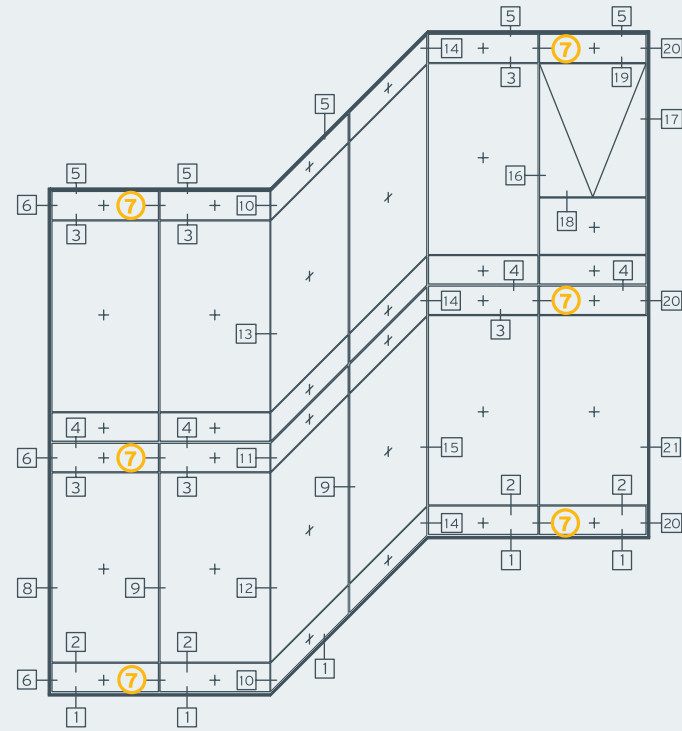

08

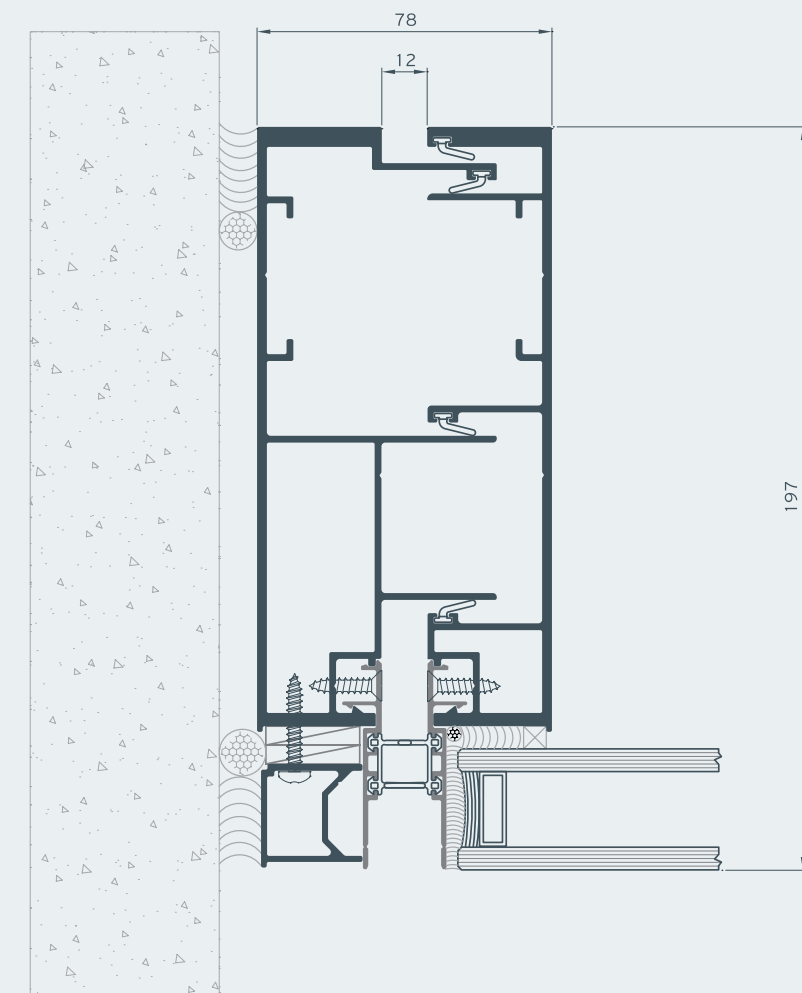
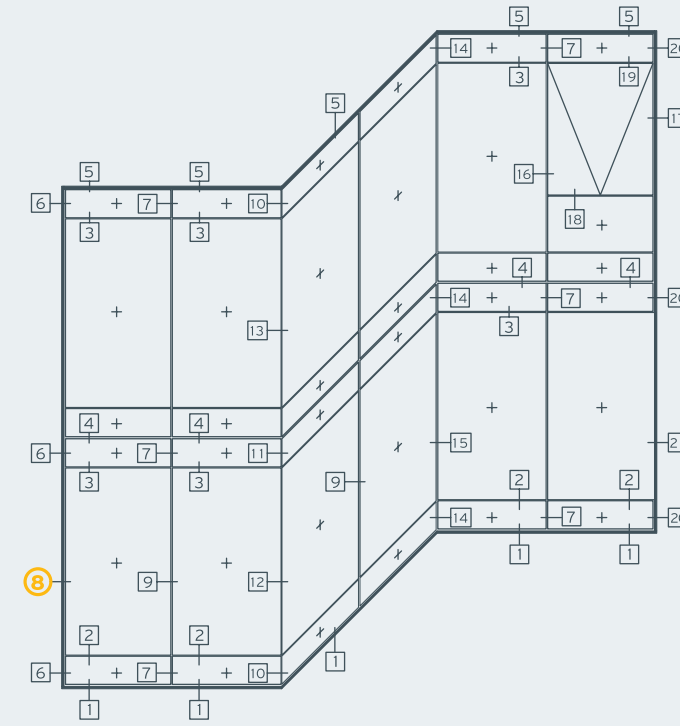

09

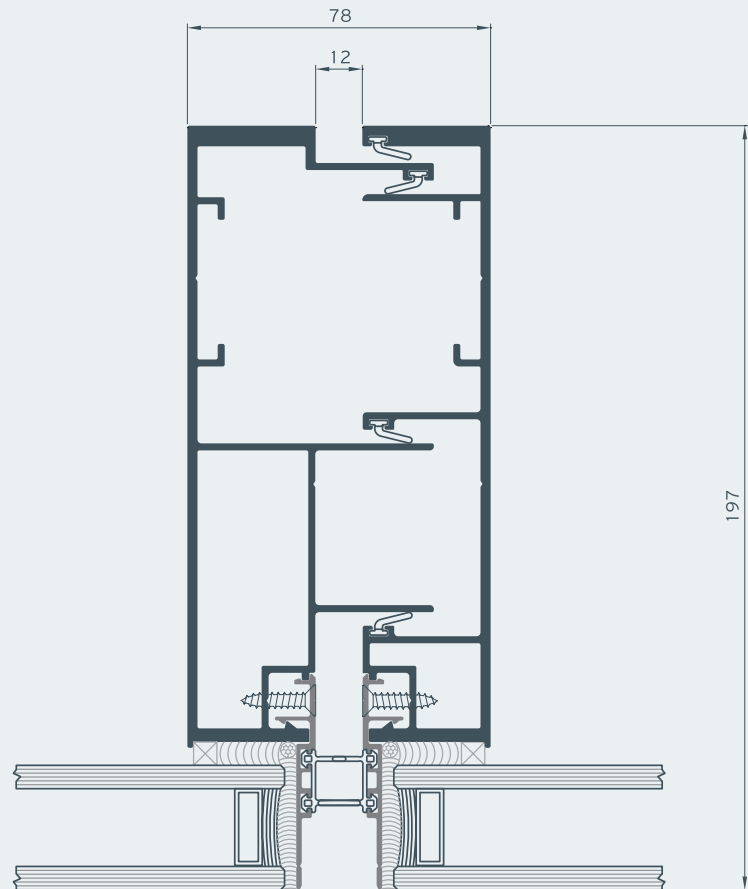
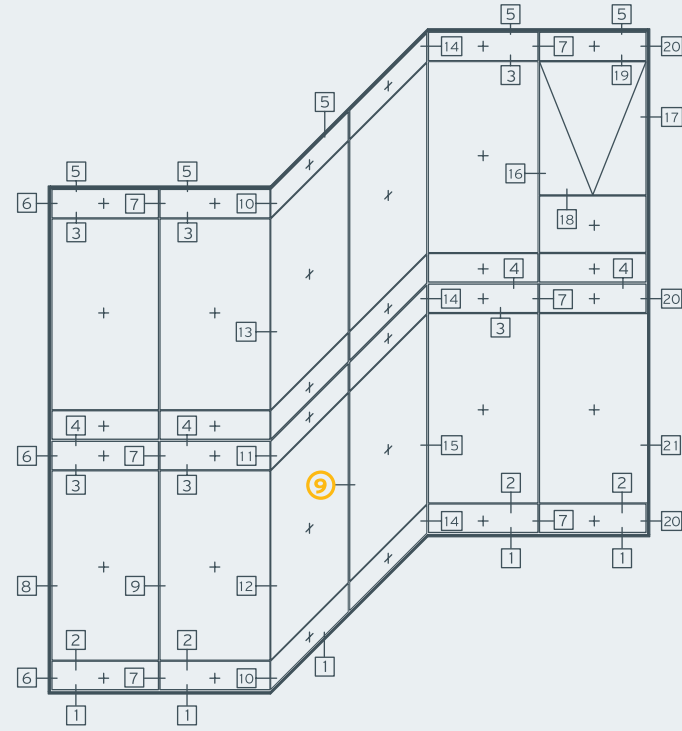

10

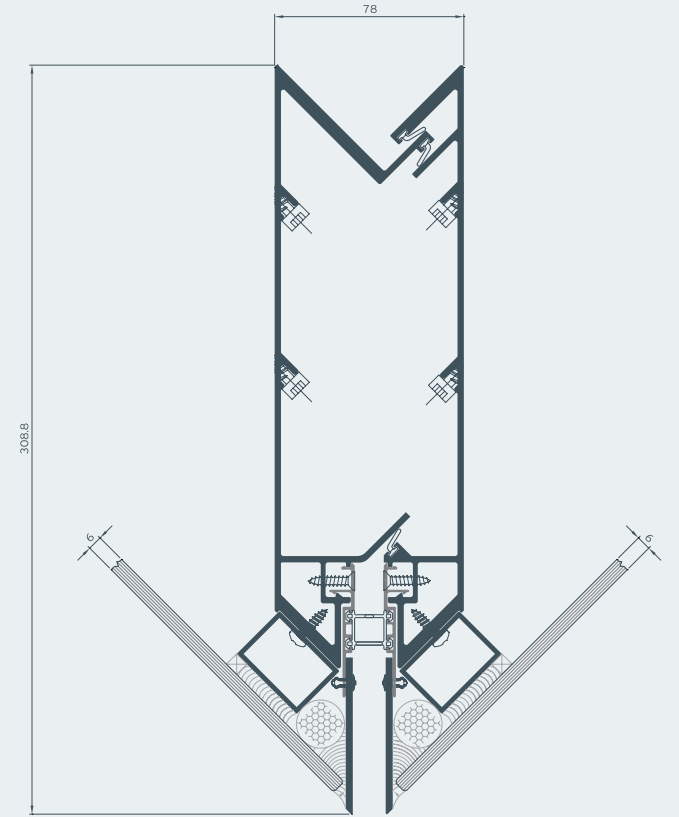
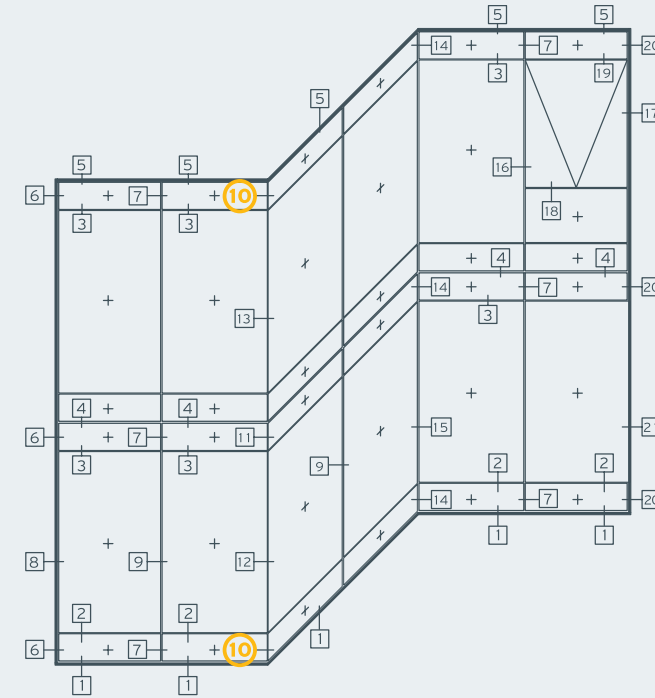

11

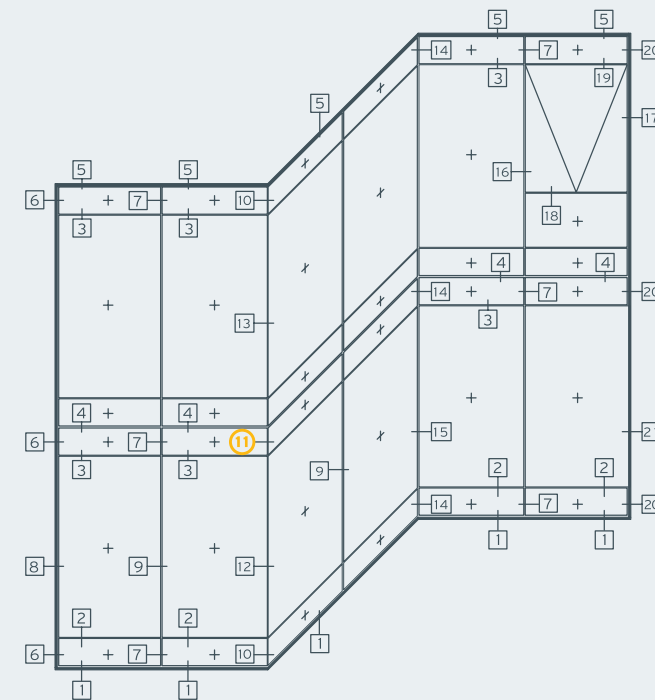

Alternative of Section 10

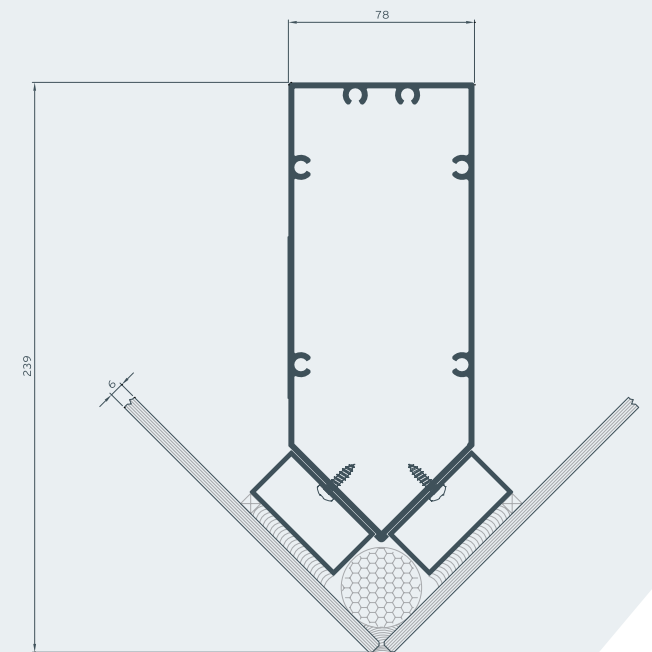

12

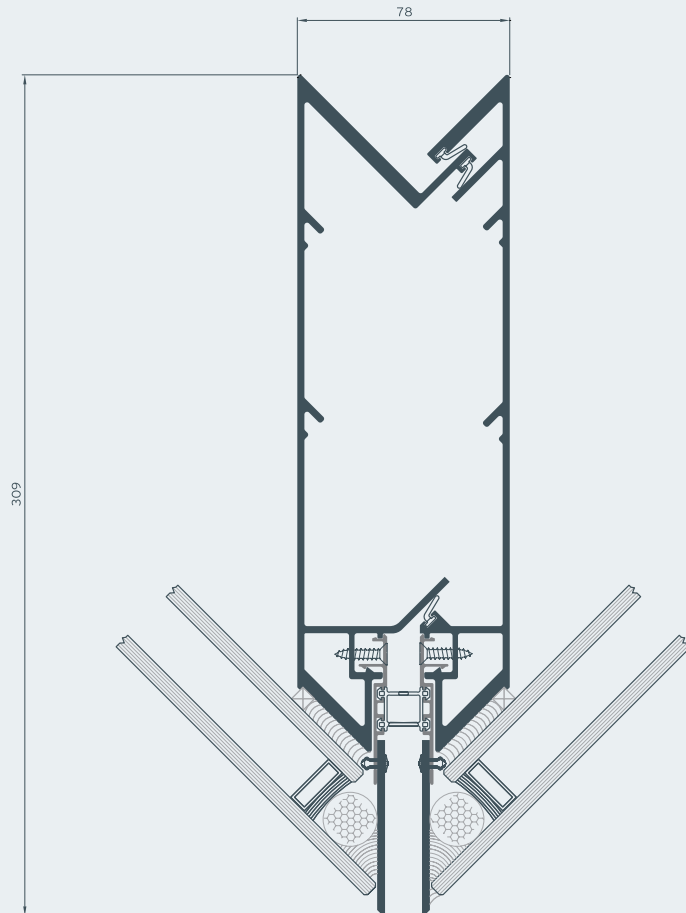
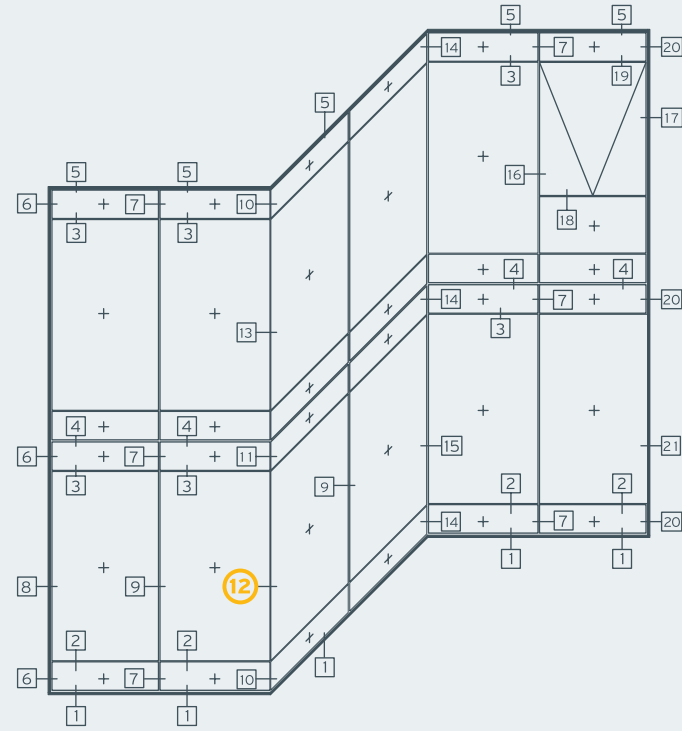

13

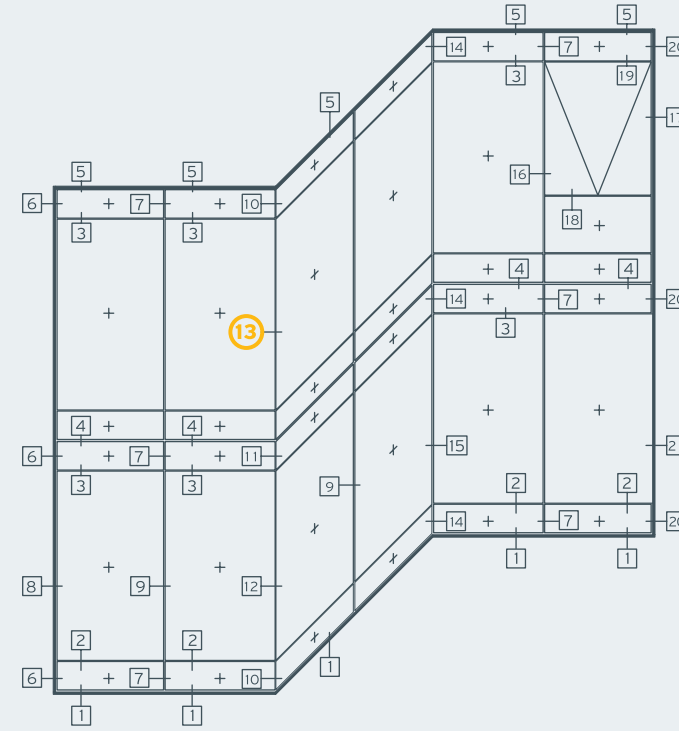

Alternative of Section 12

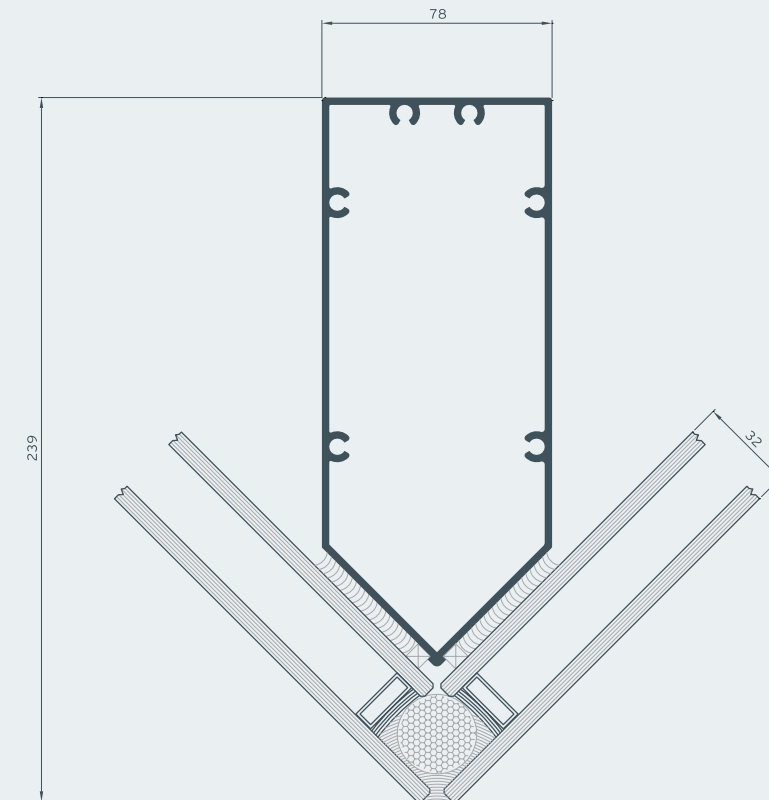

14

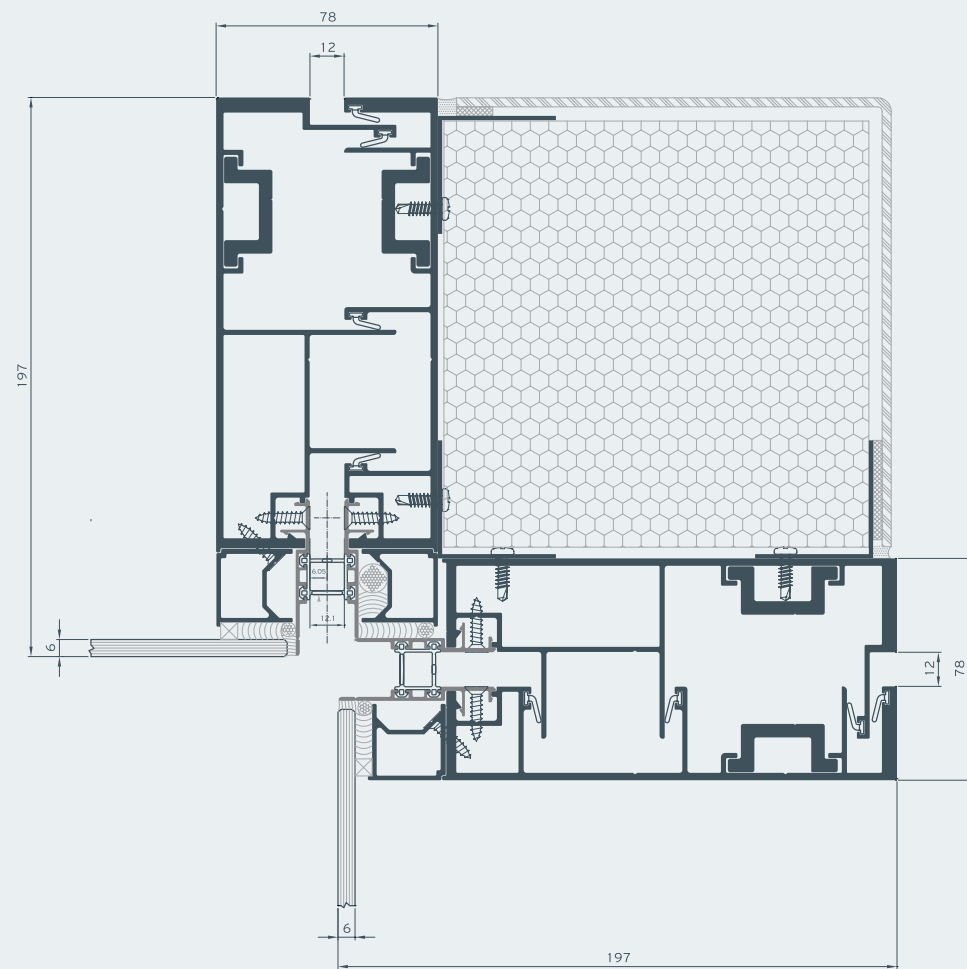
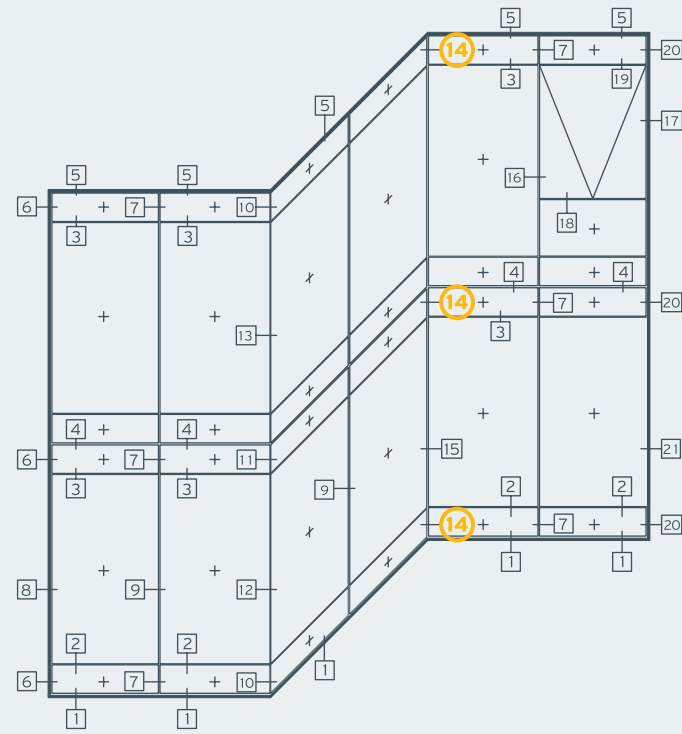

15

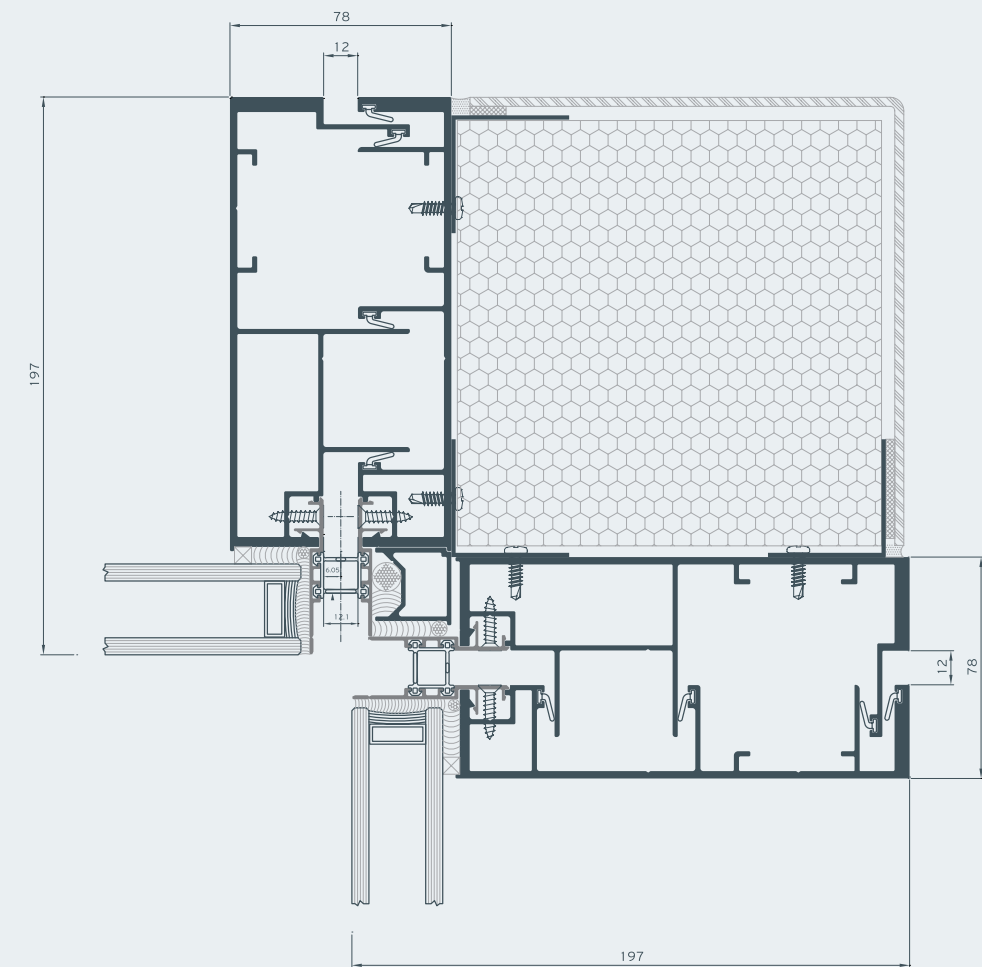
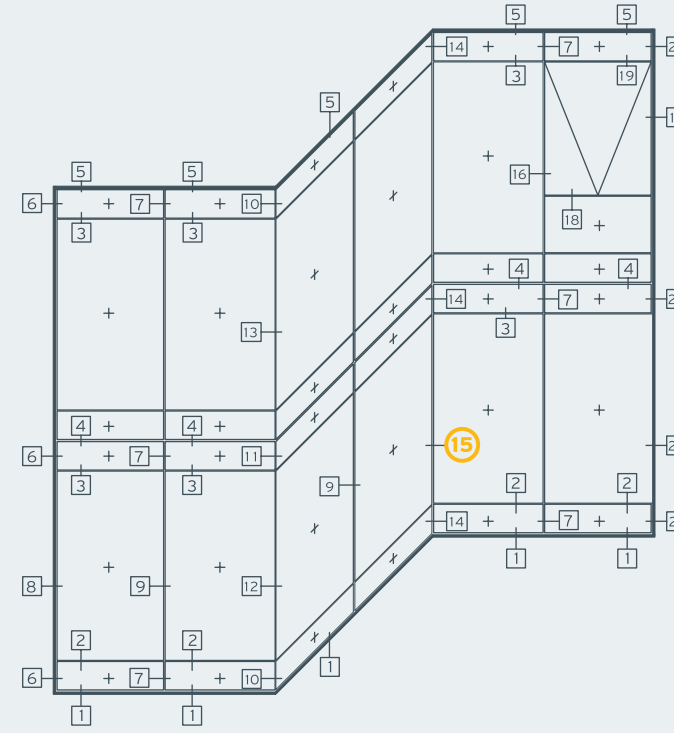

16

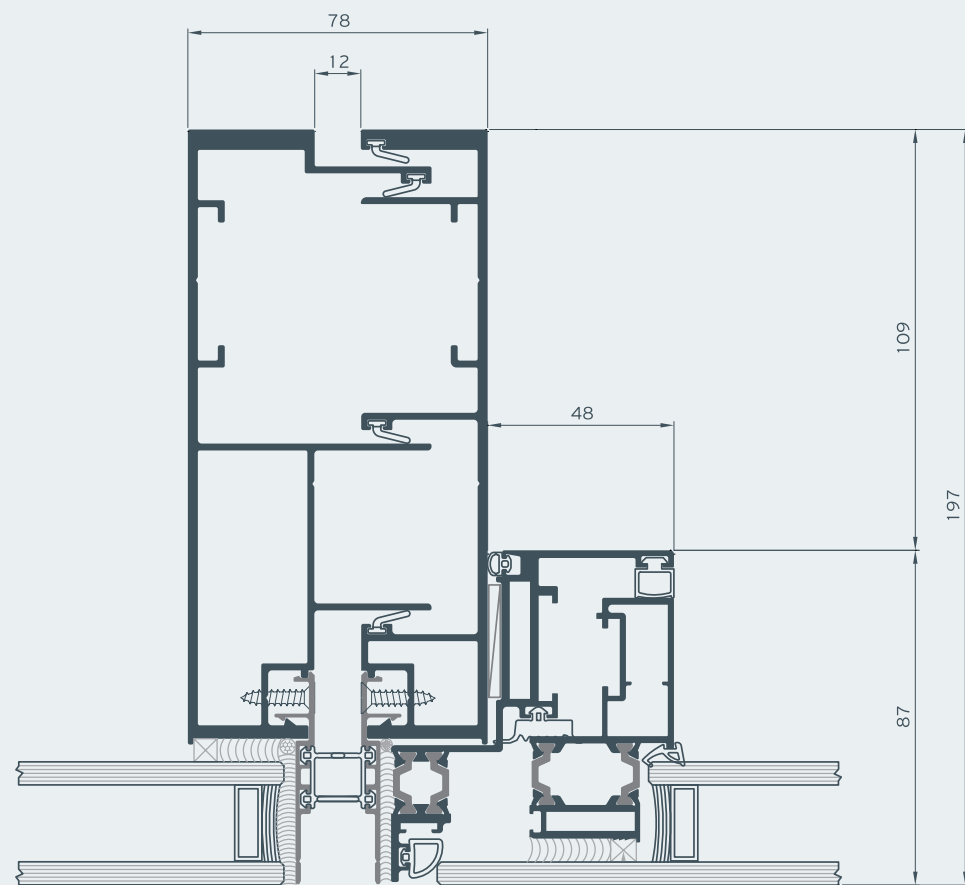
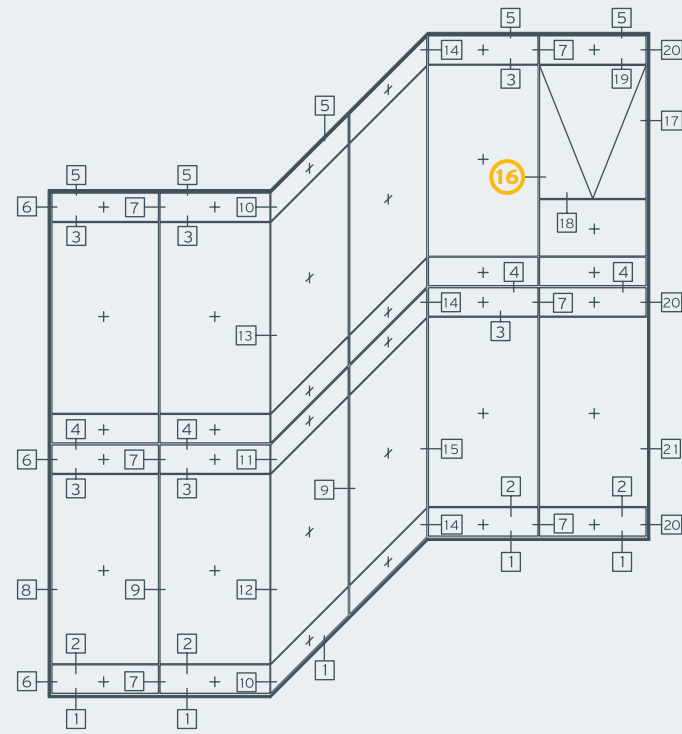

17

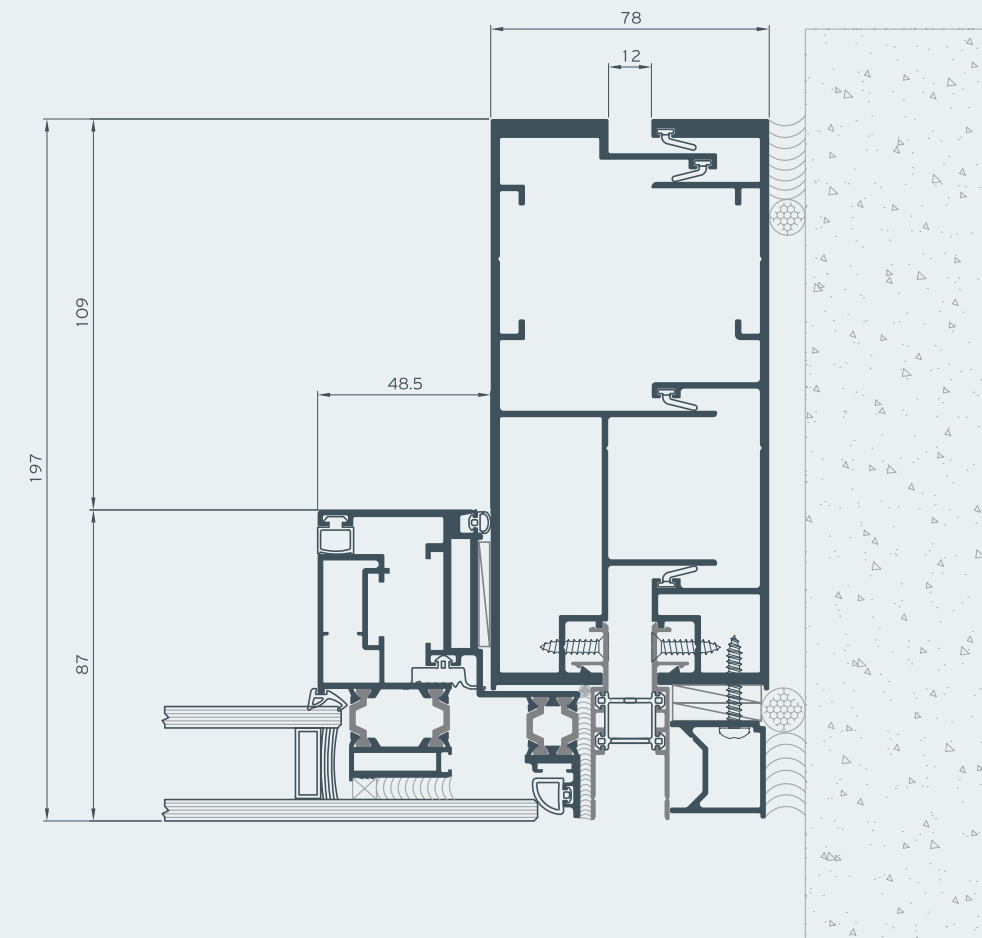
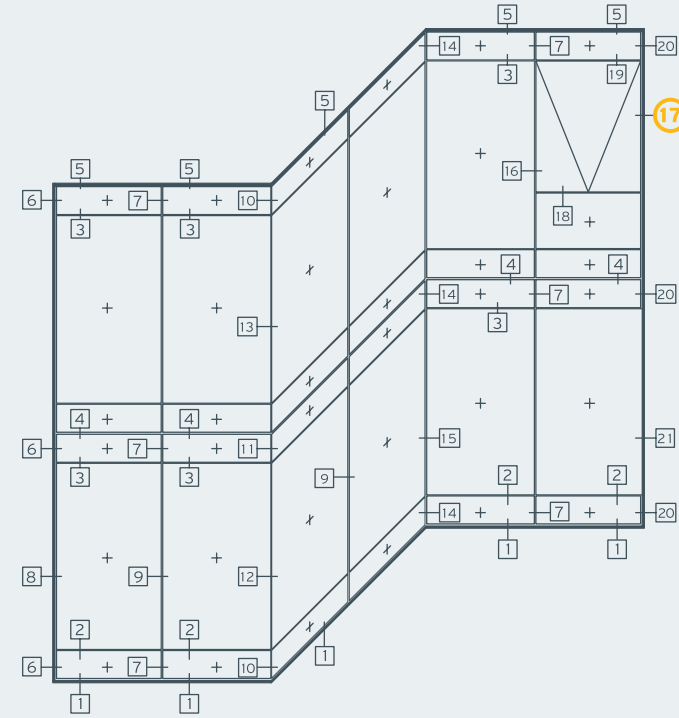

18

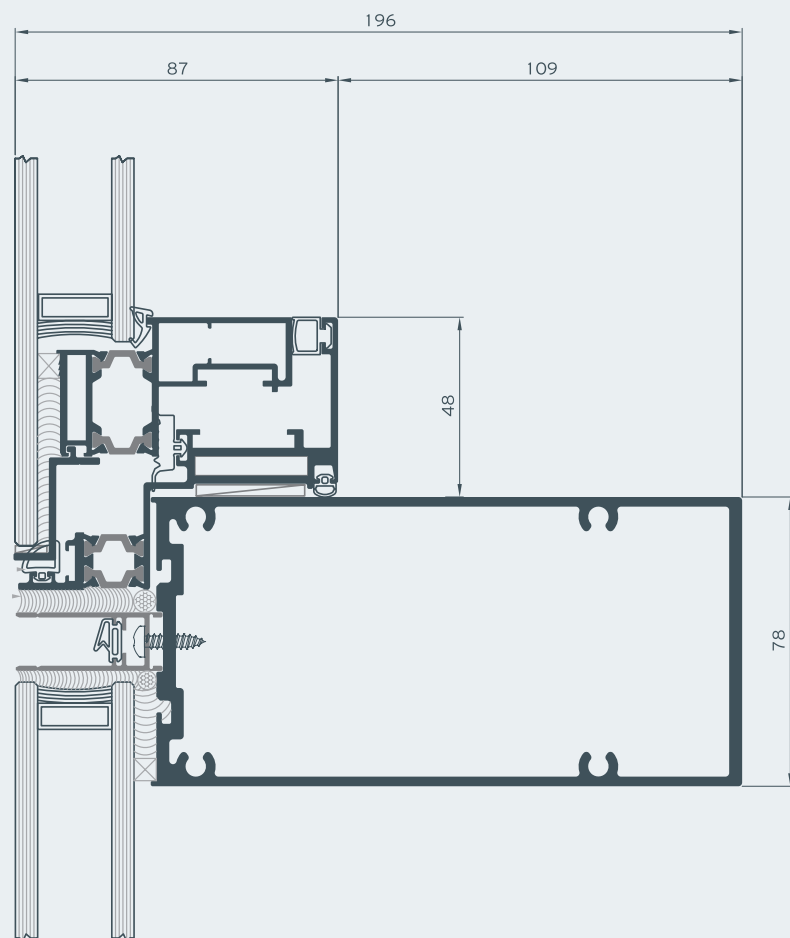
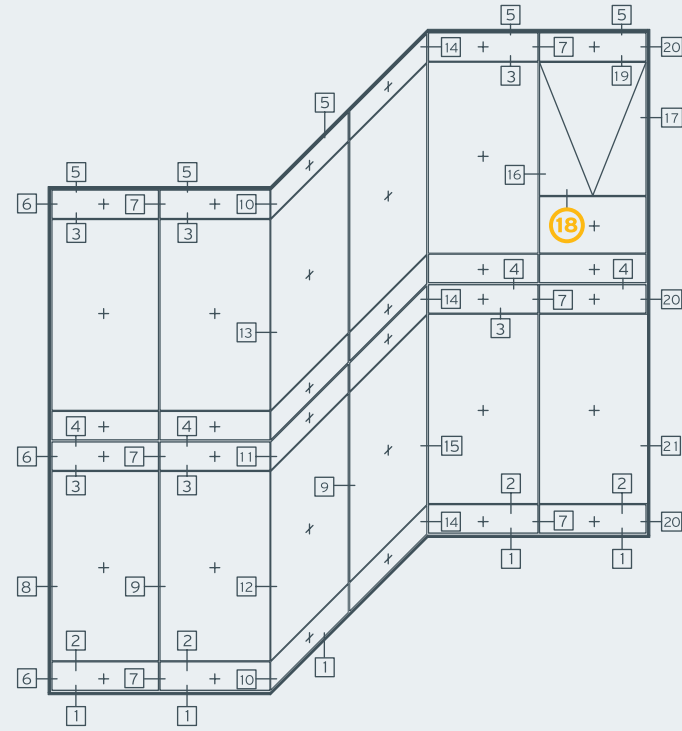

19

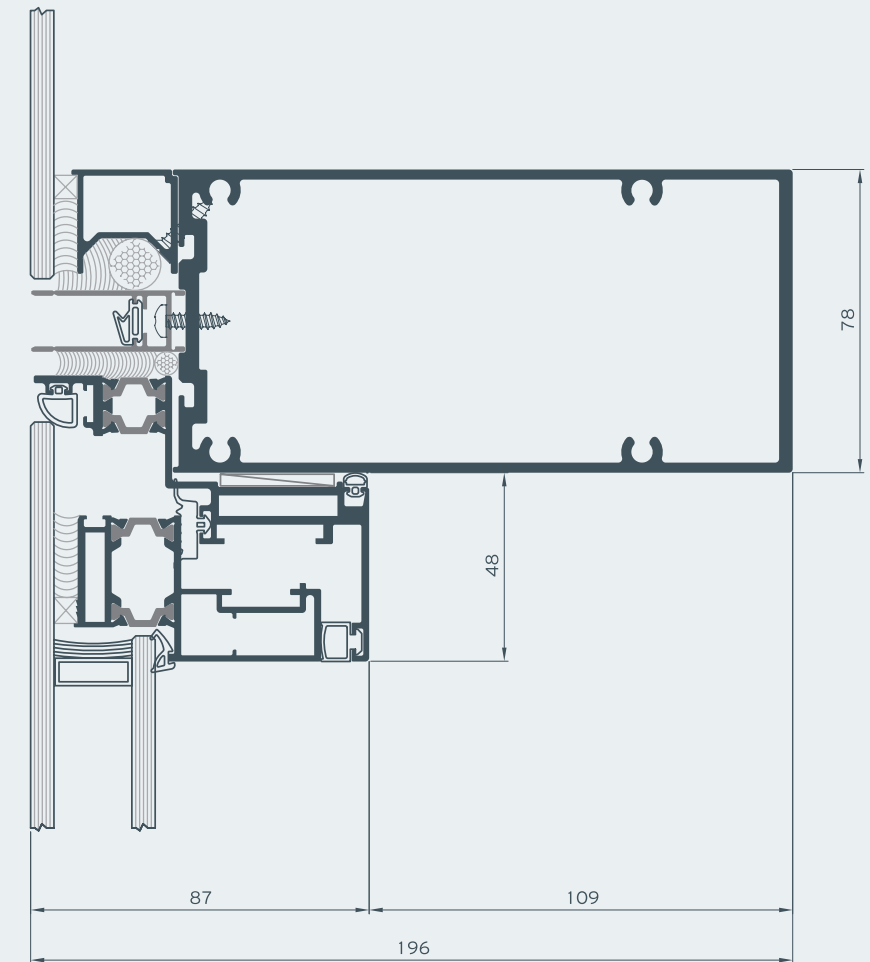
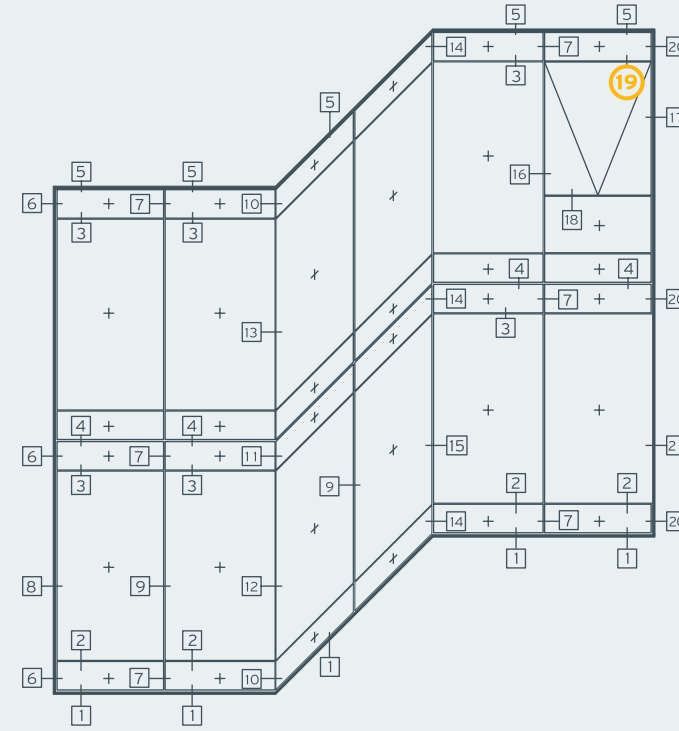

20

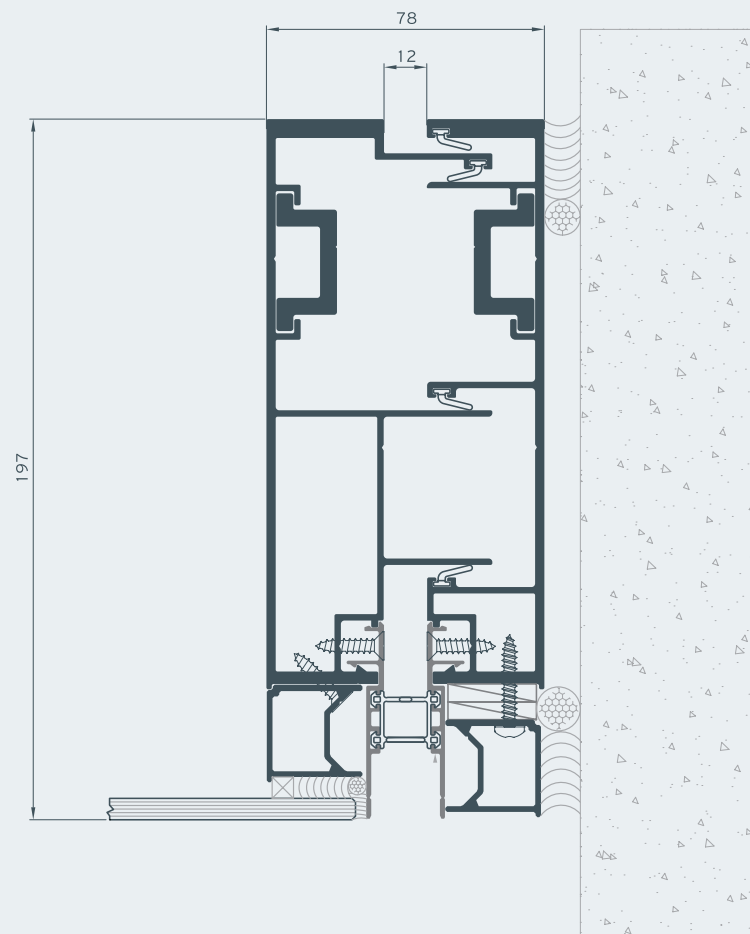
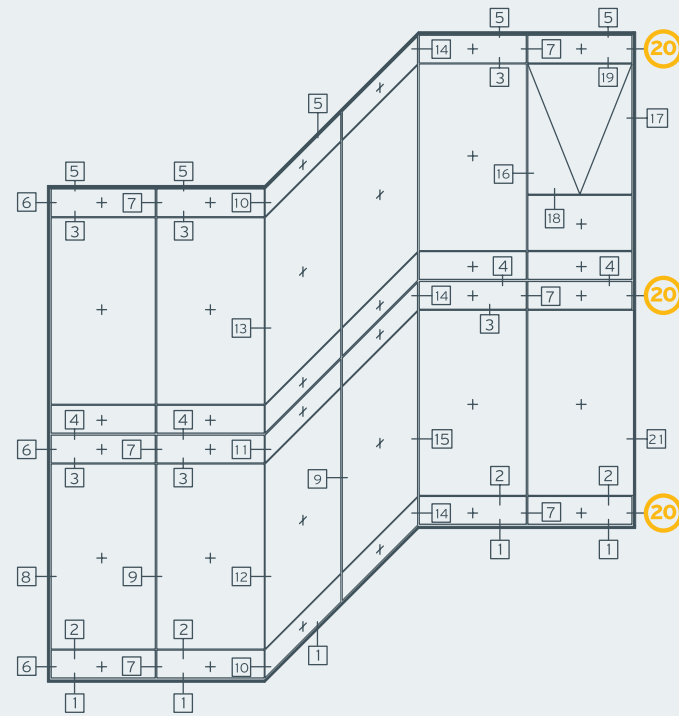

21

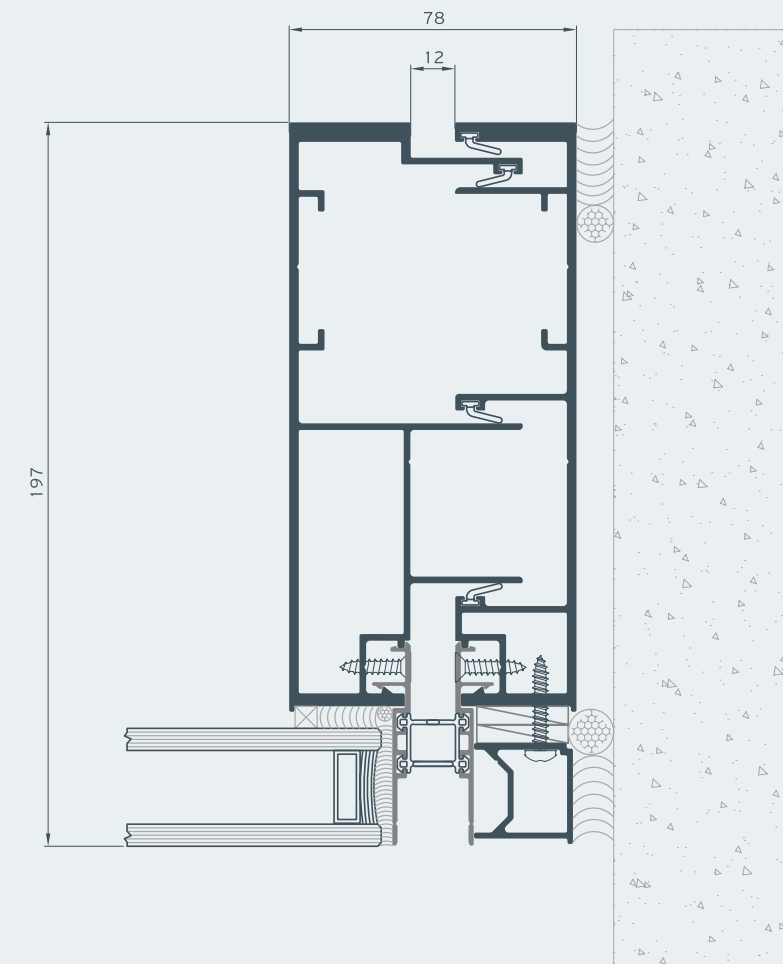
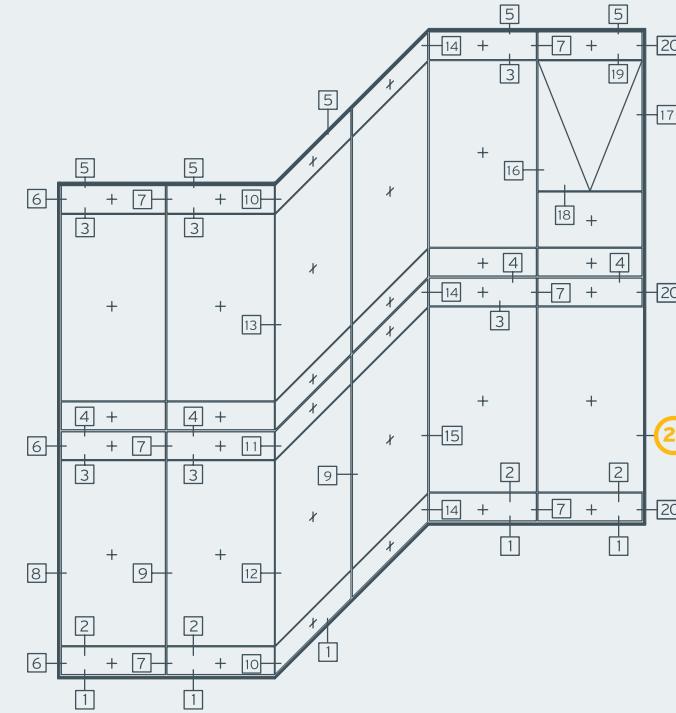

Applications

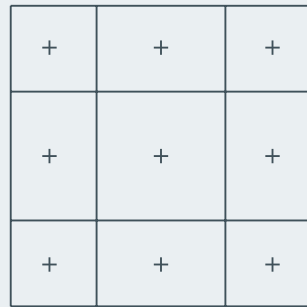

Fixed

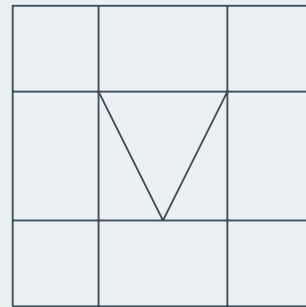

Projected window

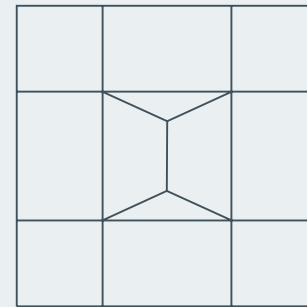

Parallel project window

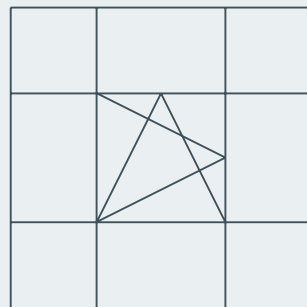



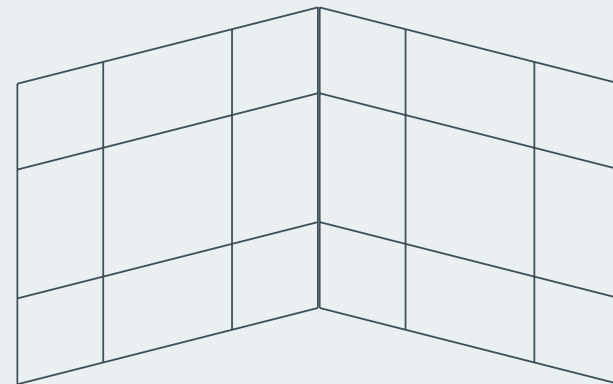

Tilt and turn window



Corner typology

Table of performance

CERTIFICATION

-  Water tightness
EN 12154
-  Air permeability
EN 12152
-  Wind load resistance,
max. test pressure
EN 13116
-  Impact Resistance
EN 14019
-  Thermal insulation
EN 12631





CLASSIFICATION

R4 (150 Pa)	R5 (300 Pa)	R6 (450 Pa)	R7 (600 Pa)	RE1200 (1200 Pa)
A1 (150 Pa)	A2 (300 Pa)	A3 (450 Pa)	A4 (600 Pa)	AE (>600 Pa)
DESIGN LOAD ±2000 Pa		SAFETY LOAD ±3000 Pa		
I1 E1	I2 E2	I3 E3	I4 E4	I5 E5

U_f down to 2,1 W/m²K depending on the profile combinations and glazing thickness



CERTIFICATION

-  Water tightness
EN 12154
-  Air permeability
EN 12152
-  Wind load resistance,
max. test pressure
EN 13116
-  Impact Resistance
EN 14019

CLASSIFICATION

R4 (150 Pa)	R5 (300 Pa)	R6 (450 Pa)	R7 (600 Pa)	RE1200 (1200 Pa)
A1 (150 Pa)	A2 (300 Pa)	A3 (450 Pa)	A4 (600 Pa)	AE (>600 Pa)
DESIGN LOAD ±2000 Pa		SAFETY LOAD ±3000 Pa		
I1 E1	I2 E2	I3 E3	I4 E4	I5 E5



Certified performances
by CWCT Bath(UK)

**ALUMIL
HEAD OFFICES
& SHOWROOM - THESSALONIKI**

Goçousi 8, Efkarpia
Thessaloniki - GR 56429
Tel.: +30 2313 011000
Fax: +30 2310 692473
E-mail: info@alumil.com

**ALUMIL
HEADQUARTERS**

Kilkis Industrial Area
Kilkis - GR 61100
Tel.: +30 23410 79300
Fax: +30 23410 71988
Email: info@alumil.com

